

DME SWITCHER

DFS-700
DFS-700P

DIGITAL/ANALOG INPUT BOARD

BKDF-701

ANALOG COMPOSITE INPUT BOARD

BKDF-702/702P

DIGITAL MULTI EFFECTS BOARD

BKDF-711

3D VIDEO MAPPING EFFECTS BOARD

BKDF-712

SERVICE MANUAL

Volume 1 1st Edition

Table of Contents

Manual Structure

Purpose of this manual	5
Related manuals	5
Contents	5

1. Operating Instructions

2. Service Overview

2-1. Installation	2-1
2-1-1. Operating Environment	2-1
2-1-2. Power Supply Specifications	2-1
2-1-3. Power Supply Cord	2-1
2-1-4. Installation Space	2-2
2-1-5. Matching Connector and Cable	2-3
2-1-6. Signal Input/Output	2-4
2-1-7. Rack Mounting	2-7
2-1-8. Installing Optional Board	2-9
2-2. Removal of Cabinet	2-10
2-3. Location of Main Parts	2-11
2-4. Circuit Description	2-12
2-4-1. Processor	2-12
2-4-2. Control Panel	2-19
2-5. Replacement of Board	2-21
2-5-1. Replacement of Plug-in Board	2-21
2-5-2. Replacement of Board	2-21
2-6. Replacement of Switching Regulator	2-22
2-7. Replacement of DC Fan	2-23
2-8. Replacement of Main Parts on Control Panel	2-23
2-8-1. Replacement of Fader Assembly	2-23
2-8-2. Replacement of Rotary Encoder	2-24
2-8-3. Replacement of Joystick	2-25
2-8-4. Replacement of Vacuum Fluorescent Display	2-25
2-9. Fuse/IC Link Replacement	2-26
2-10. Switch, Indicators, and Volume Controls on Board	2-27
2-10-1. Control Panel	2-27
2-10-2. Processor	2-28
2-11. Error Indication	2-41
2-12. Periodic Inspection	2-42
2-12-1. Periodic Replacement Parts	2-42
2-12-2. Filter Cleaning	2-42

2-13.	Fixtures/Measuring Instruments	2-42
2-13-1.	Fixtures	2-42
2-13-2.	How to Use Extension Board	2-43
2-13-3.	Measuring Instruments	2-43

3. Self-diagnosis

3-1.	Confirmation of Version	3-2
3-1-1.	Execution	3-2
3-1-2.	Viewing the Version	3-3
3-2.	Check Mode	3-3
3-2-1.	Activation and Termination	3-3
3-2-2.	Basic Operation	3-4
3-2-3.	Checking	3-5
3-3.	Troubleshooting	3-9

4. Electrical Alignment

4-1.	Adjustment Sequence	4-1
4-2.	Preparation for Adjustment	4-4
4-3.	OPM-39/39P Board Adjustment	4-5
4-3-1.	+5 V DC Voltage Adjustment	4-5
4-3-2.	+3.3 V DC Voltage Adjustment	4-5
4-3-3.	SDI VCO Free-running Frequency Adjustment	4-6
4-3-4.	PGM OUT Component Y Gain Adjustment	4-7
4-3-5.	PGM OUT Component R-Y Gain Adjustment	4-8
4-3-6.	PGM OUT Component B-Y Gain Adjustment	4-9
4-3-7.	PGM OUT Component Y/C Delay Adjustment	4-10
4-3-8.	Composite SC Leak Balance Adjustment	4-11
4-3-9.	Composite Y Gain Adjustment	4-12
4-3-10.	Composite Modulation AXIS Adjustment	4-13
4-3-11.	Composite Y/C Delay Adjustment	4-15
4-3-12.	Composite C Gain Adjustment	4-16
4-3-13.	Composite Burst Balance Adjustment (For PAL only)	4-18
4-3-14.	Composite Burst Level Adjustment	4-19
4-3-15.	S VIDEO Y Gain Adjustment	4-20
4-3-16.	S VIDEO C Gain Adjustment	4-21
4-3-17.	Black Burst OUT SC Leak Balance Adjustment	4-22
4-3-18.	Black Burst OUT Burst Balance Adjustment (For PAL only)	4-23
4-3-19.	Black Burst OUT SC Phase Adjustment	4-24
4-3-20.	Black Burst OUT SYNC Level Adjustment	4-26
4-3-21.	Black Burst OUT Burst Level Adjustment	4-27
4-3-22.	INT SC Frequency Adjustment	4-28
4-3-23.	INT SCH Phase Adjustment	4-29

4-3-24.	INT Black Burst OUT SCH Phase Adjustment	4-31
4-3-25.	Preread ON PGM OUT SCH Phase Adjustment (For PAL only)	4-33
4-3-26.	Preread ON PGM OUT Burst Start Adjustment (For PAL only)	4-34
4-3-27.	GEN Lock H Phase Adjustment	4-35
4-3-28.	GEN Lock SC Phase Adjustment	4-36
4-3-29.	PVW OUT Video Gain Adjustment	4-38
4-3-30.	DSK EXT Key Clamp Level Adjustment	4-39
4-3-31.	DSK EXT Key Gain Adjustment	4-40
4-4.	IPM-96/96P Board Adjustment	4-41
4-4-1.	SDI VCO Free-running Frequency Adjustment	4-41
4-4-2.	Component Y Level Adjustment	4-42
4-4-3.	Component Chroma Level Adjustment	4-43
4-4-4.	Input Y/C Delay Adjustment	4-45
4-4-5.	Video Input Phase Adjustment	4-46
4-4-6.	RGB Converted Y Level Adjustment	4-47
4-4-7.	RGB Converted Chroma Level Adjustment	4-48
4-5.	VIF-19/19P Board Adjustment	4-50
4-5-1.	Composite Y Level Adjustment	4-50
4-5-2.	S VIDEO Clamp DC Level Adjustment	4-52
4-5-3.	SYNC Separate Adjustment	4-54
4-5-4.	H Lock Loop Adjustment	4-55
4-5-5.	Burst Delay Adjustment	4-57
4-5-6.	Composite Input Y Gain Adjustment	4-59
4-5-7.	Composite Input Chroma Level Adjustment	4-61
4-5-8.	S VIDEO Input Gain Adjustment	4-63
4-5-9.	Composite Input Y/C Delay Adjustment	4-65
4-5-10.	S VIDEO Input Y/C Delay Adjustment	4-69
4-5-11.	Video Input Phase Adjustment	4-73
4-6.	VIF-20/20P Board Adjustment	4-74
4-6-1.	SDI VCO Free-running Frequency Adjustment	4-74
4-6-2.	Component Y Level Adjustment	4-75
4-6-3.	Component Chroma Level Adjustment	4-76
4-6-4.	Input Y/C Delay Adjustment	4-78
4-6-5.	Video Input Phase Adjustment	4-79
4-7.	Adjusting the Power Supply Voltage	4-80

Manual Structure

Purpose of this manual

This manual is the service manual Vol.1 of the DME Switcher DFS-700/700P and their optional boards.

The service manuals (Vol.1 and Vol.2) are intended for use by trained system and service engineers, and describes the information on installing, maintenance, and detailed service.

This manual (Vol.1) describes the operating instructions, service overviews, diagnosis, and electrical alignment.

Related manuals

Besides this Service Manual Vol.1, the following manuals are available for the DFS-700/700P.

- **Service Manual Vol.2**

Part No. 9-967-898-01 (for J, UC, CE)

Contains the spare parts, semiconductor pin assignments, block diagrams, schematic diagrams, and board layouts.

- **“Semiconductor Pin Assignments” CD-ROM (available on request)**

This “Semiconductor Pin Assignments” CD-ROM allows you to search for semiconductors used in Communication System Solutions Network Company equipment. Semiconductors that cannot be searched for on this CD-ROM are listed in the service manual for the corresponding unit. The service manual contains a complete list of all semiconductors and their ID Nos., and thus should be used together with the CD-ROM. Part number: 9-968-546-XX

Contents

This manual is organized by following sections.

Section 1 Operating Instructions

This section describes the Operation Manual supplied with the DFS-700/700P.

Section 2 Service Overview

This section explains the information that is required for installing (the operating conditions, power supply and power cords, installation of the optional board, rack mounting, adaptive connectors), outline of the board circuit, replacement of the parts, switch setting on the board, error indication, and tools and adjustment equipment.

Section 3 Self-diagnosis

This section explains the activation (termination) of the check mode in this unit, the basic operation, and the check method.

Section 4 Electrical Alignment

This section explains the adjustment of the OPM-39, IPM-69, VIF-19, and VIF-20 boards.

Section 1 Operating Instructions

This section is extracted
from operation manual.

3-203-834-11(1)

SONY®

SONY

DFS-700/700P

DME Switcher

Operating Instructions

Before operating the unit, please read this manual thoroughly and retain it for future reference.

DFS-700/700P

© 2000 Sony Corporation

Owner's Record

The model and serial numbers are located in the rear. Record these numbers in the spaces provided below. Refer to them whenever you call upon your Sony dealer regarding this product.

Model No. _____ Serial No. _____

WARNING

To prevent fire or shock hazard, do not expose the unit to rain or moisture.

For customers in the USA (DFS-700 only)

This equipment has been tested and found to comply with the limits for a Class A digital device, pursuant to Part 15 of the FCC Rules. These limits are designed to provide reasonable protection against harmful interference when the equipment is operated in a commercial environment. This equipment generates, uses, and can radiate radio frequency energy and, if not installed and used in accordance with the instruction manual, may cause harmful interference to radio communications. Operation of this equipment in a residential area is likely to cause harmful interference in which case the user will be required to correct the interference at his own expense.

You are cautioned that any changes or modifications not expressly approved in this manual could void your authority to operate this equipment.

The shielded interface cable recommended in this manual must be used with this equipment in order to comply with the limits for a digital device pursuant to Subpart B of Part 15 of FCC Rules.

Caution

Television programs, films, video tapes and other materials may be copyrighted. Unauthorized recording of such material may be contrary to the provisions of the copyright laws.

For the customers in Europe (DFS-700P only)

This product with the CE marking complies with both the EMC Directive (89/336/EEC) and the Low Voltage Directive (73/23/EEC) issued by the Commission of the European Community.

Compliance with these directives implies conformity to the following European standards:

- EN60950: Product Safety
- EN55103-1: Electromagnetic Interference (Emission)
- EN55103-2: Electromagnetic Susceptibility (Immunity)

This product is intended for use in the following

Electromagnetic Environment(s):

E1 (residential), E2 (commercial and light industrial), E3 (urban outdoors) and E4 (controlled EMC environment, ex. TV studio).

Table of Contents

Chapter 1

Overview

Features of This System	1-1
Option Boards	1-3

Chapter 2

Location and Function of Parts and Controls

Control Panel	2-1
Processor Unit	2-13
Front Panel	2-13
Rear Panel	2-13

Chapter 3

Basic Operation

DME Switcher Introduction	3-1
Sequence of Operations	3-1
Example Operation (1): Wipe	3-2
Example Operation (2): Picture-in-Picture	3-5
Demonstration	3-8
Using the Menus	3-10
Selecting Images	3-12
Background Image and Foreground Image	3-12
Selecting Signals Output to the Auxiliary Bus	3-16
Selecting an Effect	3-17
Types of Effect	3-17
Example Effects	3-18
Selection in Direct Pattern Selection Mode	3-23
Selection in Pattern Number Specification Mode	3-24
Modifying the Boundary — Border, Soft Edge, Beveled Edge, and Crop	3-26
Changing the Pattern Position and Size — Location (X)(Y)(Z)	3-29
Modifying the Pattern — User Modifiable Effects	3-31

(Continued)

Table of Contents

Chapter 3

Basic Operation

(Continued)

Inserting Characters and Graphics (1) — Title Key ...	3-33
Luminance Key	3-33
Chroma Keying	3-36
Masking Part of a Title Key	3-44
Inserting Characters and Graphics (2) —	
Downstream Key	3-45
Setting Up a Transition	3-51
Setting the Transition Time	3-51
Setting the Transition Direction	3-52
Executing an Effect	3-54
Adjusting Color Mattes	3-57
Adjusting Image Colors — Color Correction	3-59
Freezing an Input Image — Frame Memory	
Function	3-61
Fade-to-Black	3-63

Chapter 4

Advanced Operations

Changing Direct Pattern Assignments	4-1
User Program Effects	4-3
Constructing a User Program Effect	4-3
Types of User Program Effect	4-4
Modification Parameters	4-5
Creating New User Program Effects	4-10
Editing User Program Effects	4-12
Executing User Program Effects	4-18
Deleting All User Program Effects	4-19
Snapshots	4-20
Saving a Snapshot	4-21
Recalling a Snapshot	4-22
Snapshot Demonstration	4-23
Reinitializing the Snapshots	4-24

Chapter 5

Control From Editing Control Units

Control From the PVE-500	5-1
Preparations	5-2
Cut Editing	5-2
A/B Roll Editing	5-3
Control From the BVE-600	5-5
Preparations	5-5
A/B Roll Editing	5-6
Control From the BVE-900/2000 Series	5-8
Preparations	5-9
Notes on Operation	5-10
Control Using GPI Signals	5-11
Preparations	5-11
A/B Roll Editing	5-12
Turning a Downstream Key On and Off	5-13
Preread Editing	5-14

Chapter 6

System Connections and Settings

Basic System Connections	6-2
Key Signal Connections	6-3
System Connections for Preread Editing	6-4
Connections for an A/B Roll Editing System	6-5
Setup Menu Settings	6-7
Setup Menu Organization	6-7
System Setup (page 1/8)	6-7
System Information Display (page 2/8)	6-8
Input Video Setup (page 3/8)	6-8
Output Video Setup (page 4/8)	6-9
Control Panel Setup (page 5/8)	6-10
Initializing User Settings (page 6/8)	6-10
Loading User Settings From Memory (page 7/8)	6-10
Saving User Settings in Memory (page 8/8)	6-10

Appendixes

Warning Messages	A-1
Effect Type List	A-3
Effect Control Parameter List	A-5
Effect Motion Types	A-21
Effect Pattern Variant Forms and Decorations	A-22
Effect Pattern Image List	A-29
To Exchange the Button Labels	A-63
Specifications	A-64
Glossary	A-66
Index	I-1

Overview

Features of This System

The Sony DFS-700/700P DME Switcher is a Digital Multi Effects system, offering high-performance effects at high image quality. The system consists of a processor unit and control panel.

Support for fully digital component systems with SDI inputs and outputs

This system provides SDI interfaces as standard equipment. This allows it to be incorporated in fully digital linear editing systems using DVCAM-series, Betacam SX-series, and other digital VCRs.

Advanced special effects

This system is equipped with advanced special effects, including trail, lighting effects, ripple, swirl, and explosion. Installing the optional BKDF-711 board adds a second DME channel, and the optional BKDF-712 board enables 3D mapping effects to be used.

For details of option boards, see page 1-3.

Support for wide range of input/output signal formats

- There are eight inputs as standard (VIDEO INPUT 1 to 8).

VIDEO INPUT 1 to 4: SDI (serial digital interface) signals

VIDEO INPUT 5 to 8: analog component signals. VIDEO INPUT 8 can also be used as an analog RGB signal input.

Installing the optional BKDF-701 board allows all eight inputs to be used as either SDI or analog component inputs.

Installing the optional BKDF-702/702P board allows four inputs to be used as either Y/C (S-video) or analog composite inputs.

For details of option boards, see page 1-3.

- The standard outputs are two each of SDI, analog component, analog composite, and Y/C, for a total of eight outputs.

Comprehensive title key functions

Luminance keys, chroma keys, and downstream keys are all provided as standard functions.

Features of This System

Color correction function

A YUV color correction function is provided for white balance adjustment and general color adjustment.

User program effect and snapshot function

- **User program effects:** This system has a large number of built-in effects, but also allows the user to create original effects, and save them in memory, for execution in the same way as the built-in effects. Up to twenty user program effect patterns, both linear and nonlinear, can be saved.
- **Snapshot function:** The processor unit includes snapshot registers 0 to 99, each of which can hold a snapshot of the control panel settings. These can then be recalled as required.

Aspect ratio selection

In the setup menu it is possible to select either 4:3 or 16:9 as the screen aspect ratio.

Easy operation for live broadcasting

The following features make this system suitable for live broadcasting from CATV studios and so on.

- Fully-equipped control panel offers easy operability for signal selection and transition setting.
- Parallel tally output and preview output supplied as standard

Interfacing with editors

This system is equipped with I/O interfaces for two sets of control signals, allowing operation together with various editing control units.

- **Nine-pin interface connector (one input/output):** for A/B roll editing (two players, one recorder) together with a PVE-500, BVE-2000 series, or other editing control unit
- **GPI (General Purpose Interface) and trigger signal connectors (two inputs):** for control from external equipment not fitted with the 9-pin interface

This system also supports the background through mode. If connected to a recorder VCR with a preread function, A/B roll editing with a minimum of two VCRs is possible. (In background through mode, the delay to the signal selected on the background bus of this system is 4H. Note that there are restrictions on the effect patterns that can be used for preread editing.)

External synchronizing connectors for higher editing precision

The system is provided with black burst outputs for synchronizing other connected devices, and a genlock input for synchronization to an external signal. This allows more precise editing.

Rack mounting

The processor unit can be mounted in an EIA standard 19-inch rack.

Option Boards

The DFS-700/700P system has the following option boards.

BKDF-701 SDI and Component Input Board

When this board is installed, it allows all eight video inputs to be used as either SDI or analog component inputs. When using this board, you can select the types of the optional inputs individually, using the setup menu.

BKDF-702/702P Y/C and Composite Input Board

When this board is installed, it allows four video inputs to be used as either Y/C (S-video) or analog composite inputs. When using this board, you can select the types of the optional inputs individually, using the setup menu.

BKDF-711 2nd Channel DME Board

This board provides a second DME channel, enabling two-picture box, two-picture brick, and other effects.

BKDF-712 3D Video Mapping Effects Board

This board provides 3D mapping effects, including 3D page turn, 3D beveled edge, and other effects.

Location and Function of Parts and Controls

Control Panel

This section describes the control panel, which is divided into several sections, as shown below. See the page numbers shown in parenthesis for more details.

Note

If you make an error in operation, a warning sound may occur. You can switch off this audible warning (see page 6-10).

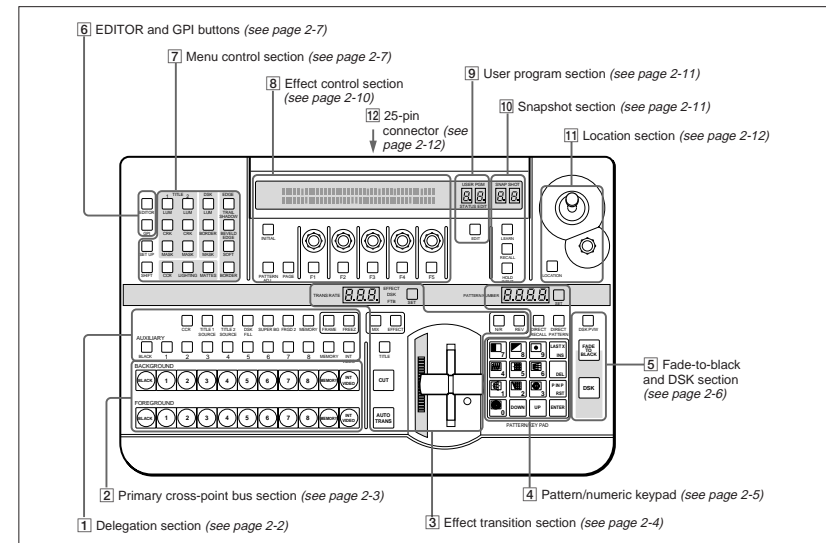

Control Panel

1 Delegation section

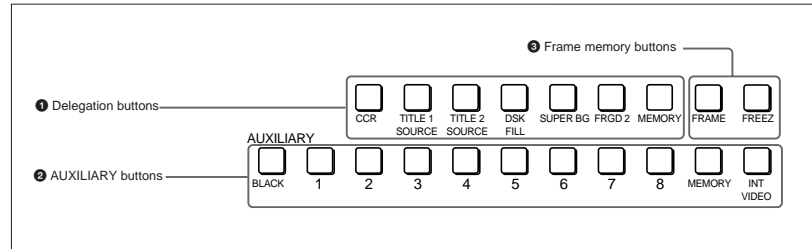

1 Delegation buttons

Use these buttons to delegate the input signal corresponding to the selected AUXILIARY button to the corresponding function. Pressing one of these buttons lights it, and the corresponding AUXILIARY button also lights. Any other previously lit delegation button goes off.

CCR (color corrector) button: Signal for color correction

TITLE 1 SOURCE button: Title 1 source signal for inserting characters and graphics using a title key

TITLE 2 SOURCE button: Title 2 source signal for inserting characters and graphics using a title key (only available when the optional BKDF-711 2nd Channel DME Board is installed)

DSK (downstream keyer) FILL button: Fill signal for the downstream keyer

SUPER BG (background) button: Background image for 3D effects

FRGD (foreground) 2 button: One of the foreground images for 3D effects

MEMORY button: Signal captured in frame memory

2 AUXILIARY buttons

Select the input signal to be assigned to the function selected with a delegation button. Select from the following buttons.

BLACK button: Black burst signal generated by the internal synchronizing signal generator in this unit

Buttons 1 to 8: Signals input to the VIDEO INPUT 1 to 8 connectors on the rear panel of the processor unit. You can set the assignment of buttons to input connectors in the setup menu.

MEMORY button: Signal recorded in frame memory

INT (internal) VIDEO button: Signal generated by the internal video signal generator

3 Frame memory buttons

FREEZ button: To capture the input signal selected by the MEMORY button in the delegation buttons (excluding the frame memory output signal) as a freeze image in frame memory, press this button, turning it on.

Press once more to end the freeze, turning it off.

FRAME button: Select whether to capture a frame or a field with the FREEZ button. Press this button, turning it on, to freeze a frame; when the button is off a field is captured.

When capturing fields, you can select in the setup menu whether to capture an odd or an even field.

2 Primary cross-point bus section

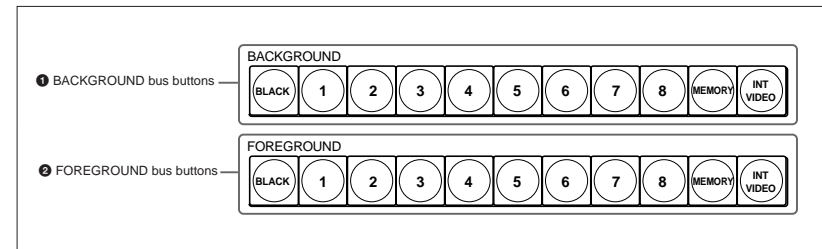

1 BACKGROUND bus buttons

Select the image to form the background for an effect. Select from the following buttons.

BLACK button: Select the black burst signal generated by the internal synchronizing signal generator in this unit.

Buttons 1 to 8: Signals input to the VIDEO INPUT 1 to 8 connectors on the rear panel of the processor unit. Press a button, turning it on, to select the corresponding signal.

You can set the assignment of buttons to input connectors in the setup menu.

MEMORY button: Select the signal recorded in frame memory.

INT (internal) VIDEO button: Select the internal video signal selected by pressing the MATTES button in the menu control section. If you hold down this button and press the DOWN and UP buttons in the pattern/numeric keypad, the selected video signal pattern changes.

When the signal on the background bus is output from the PGM OUT connector on the rear panel of the processor unit, the button which has been pressed lights red.

2 FOREGROUND bus buttons

Select the image to form the foreground for an effect (or the "new" video in a transition).

The functions of the buttons are the same as in the BACKGROUND bus buttons.

When the signal on the foreground bus is output from the PGM OUT connector on the rear panel of the processor unit, the button which has been pressed lights red. If the signal is not output, the button pressed lights amber.

Control Panel

3 Effect transition section

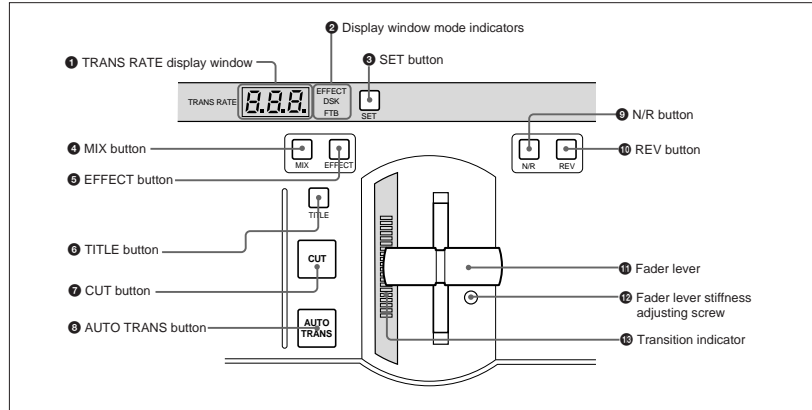

1 TRANS (transition) RATE display window

This shows the transition time for effects, downstream keys, and fade-to-black, in units of frames. While you are entering a time, the dot at the lower right of each numeral lights.

2 Display window mode indicators

These indicate the kind of transition time shown in the TRANS RATE display window.

EFFECT: Transition time of an effect
DSK: Transition time of a downstream key
FTB: Transition time of a fade-to-black

3 SET button

To set the transition time for an effect, downstream key, or fade-to-black, press this button, turning it on. While it is lit, each time you press, the display window mode indicators change. To set the transition time corresponding to the display of the display window mode indicators, enter the value using the pattern/numeric keypad.

4 MIX button

To carry out the next transition without applying an effect pattern, but as a mix, press this button, turning it on.

5 EFFECT button

To carry out the next transition with an effect pattern applied, press this button, turning it on.

6 TITLE button

To carry out an effect or a mix in title mode, press this button, turning it on. The title keying is carried out, inserting the characters and graphics with the effect pattern and transition settings applied.

7 CUT button

Press this button to carry out an instantaneous transition.

8 AUTO TRANS (automatic transition) button

Press this button to carry out an effect automatically. When you press this button, the effect is carried out automatically, with the transition time which has been set. During the transition this button is lit. Pressing this button during the transition pauses it. Press the button once more to resume the transition.

If you set the fader lever to an intermediate position and press this button, the transition pauses at the position corresponding to the fader lever position.

9 N/R (normal/reverse) button

To carry out an effect in normal/reverse (i.e. alternating) mode, press this button, turning it on. It lights automatically for animation effects and title keys.

10 REV (reverse) button

To carry out an effect in the reverse direction, press this button, turning it on. For an effect for which normal/reverse (alternating) operation is possible, once the effect is carried out, the direction is automatically reversed. After an effect is carried out in the normal (i.e. forward) direction, this button lights. After an effect is carried out in the reverse direction, this button goes off.

11 Fader lever

Move this to carry out an effect transition manually.

Note

After powering the system on, move the fader lever to the end of its travel once in each direction. This ensures that the fader lever will function correctly.

12 Fader lever stiffness adjusting screw

Turn this screw with a miniature Phillips screwdriver to adjust the fader lever stiffness. Turn clockwise to make the fader lever harder to move, and counterclockwise to make it easier to move.

13 Transition indicator

This indicator consisting of 20 LEDs shows the progress of an effect transition.

4 Pattern/numeric keypad

This is used for effect pattern selection, transition time setting, and other data entry.

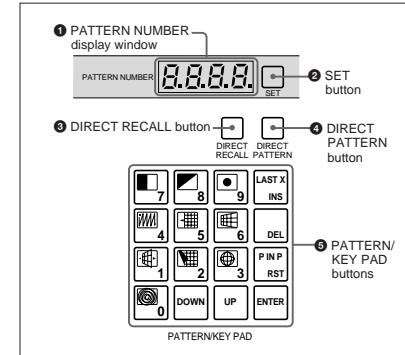

1 PATTERN NUMBER display window

This shows an effect pattern number. While you are entering a pattern number, the dot at the lower right of each numeral lights.

2 SET button

Press this button, turning it on, to enter the pattern number specification mode. In this mode, you can use the PATTERN/KEY PAD buttons to specify an effect pattern number.

Press this button once more, turning it off, to return to the direct pattern selection mode.

3 DIRECT RECALL button

Press this button, turning it on, to enter the direct recall mode. In this mode, pressing one of the PATTERN/KEY PAD buttons 0 to 9 recalls the corresponding snapshot 0 to 9.

4 DIRECT PATTERN button

Press this button, turning it on, to enter the direct pattern selection mode. In this mode, you can use the PATTERN/KEY PAD buttons (0 to 9 and P IN P/RST) to directly select the assigned effect patterns. When the system is powered on, and after exiting any other operating mode, it automatically switches to direct pattern selection mode.

Control Panel

5 PATTERN/KEY PAD buttons

These function as shown in the following table, according to the selected mode.

Changing labels

You can change the labels on the buttons, using the supplied labels.

For details of how to change the labels, see page A-63.

Functions of the PATTERN/KEY PAD buttons

Button	Mode					
	DIRECT PATTERN	PATTERN	TRANS	USER PGM	SNAP SHOT	DIRECT RECALL
0 to 9	Select the pattern shown on the button. ^{a)}	Set the pattern number.	Set the transition time.	—	Specify a snapshot number.	Recall one of snapshots 0 to 9.
LAST X/INS	—	—	—	Add a key frame.	Return to the state before recalling a snapshot. (Press LAST X while holding down the ENTER button.)	Return to the state before recalling a snapshot. (Press LAST X while holding down the ENTER button.)
DEL	—	Delete the last character entered.	Delete the last character entered.	Delete a key frame.	Delete the last character entered.	—
P IN P/RST	Select the pattern shown on the button. ^{a)}	Reset the input value.	Reset the input value.	Initialize the parameters.	Reset the input value.	—
UP	Increment the pattern number.	Increment the pattern number.	Increment the transition time by one frame.	Increment the key frame number.	Increment the snapshot number.	Increment the snapshot number.
DOWN	Decrement the pattern number.	Decrement the pattern number.	Decrement the transition time by one frame.	Decrement the key frame number.	Decrement the snapshot number.	Decrement the snapshot number.
ENTER	—	Confirm the input value.	Confirm the input value.	Change the key frame.	Confirm the input value.	Return to the state before recalling a snapshot. (Press LAST X while holding down the ENTER button.)

—: Not used

a) For the pattern allocation, see pages 3-18 to 3-20.

5 Fade-to-black and DSK section

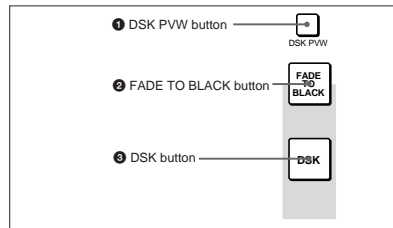

1 DSK PVW (downstream keyer preview) button

When this button is pressed, turning it on, the program output video is output from the preview output connectors with the downstream key inserted.

2 FADE TO BLACK button

Press this button, turning it on, to change the entire program output video to a preset color (factory default: black). To set the color, press the MATTES button in the menu control section, and display the setting menu in the effect control section ((F1) SELECT-FTB).

By pressing the SET button in the effect transition section, you can set the fade-to-black transition time.

3 DSK (downstream keyer) button

Press this button, turning it on, to insert the downstream key set by the DSK section buttons in the menu control section into the program output video. By pressing the SET button in the effect transition section, you can set the downstream key transition time.

6 EDITOR and GPI buttons

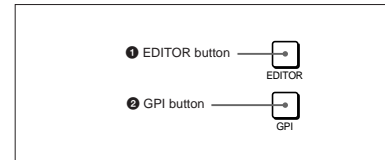

1 EDITOR button

Press this button, turning it on, to accept control from an external editor connected to the EDITOR connector on the rear panel of the processor unit.

Press this button once again to turn it off; control is no longer accepted from the external editor.

2 GPI button

Press this button, turning it on, to accept GPI signals input to the GPI/T 1 and 2 connectors on the rear panel of the processor unit.

Press this button once again to turn it off; GPI signals are no longer accepted.

7 Menu control section

For various effect settings, you press a particular button in the menu control section, to display a setting menu in the effect control section. Some buttons toggle on and off when pressed: in this case the corresponding effect is disabled when the button is off.

Displaying the menu for a button already lit

Hold down the SHIFT button and press the button again. This leaves the button lit (and the effect enabled), while bringing up the menu in the effect control section. For the LUM and CRK buttons in the TITLE section, it is not necessary to hold down the SHIFT button.

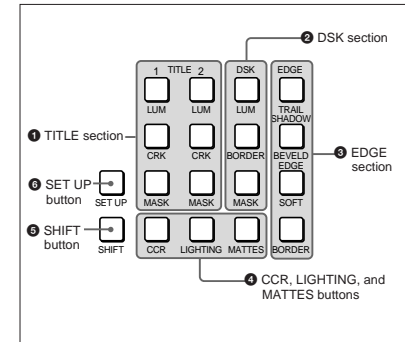

1 TITLE section

The title key function allows you to superimpose characters or graphics by cutting out part of the foreground video with a key source signal, and applying the effect to the background video.

There are two ways of using the key source signal: as a luminance key depending only on image intensity, or as a chroma key, based on a particular color.

Using the buttons in columns 1 and 2 of the TITLE section, you can insert two title keys (TITLE 2 requires the optional BKDF-711 board to be installed). To insert a title key, press the TITLE button in the effect transition section.

The TITLE 1 and TITLE 2 buttons include the following.

CRK (chroma key) button: Press this to use a chroma key to cut out the image. When pressed, this button lights, and portions of the foreground image of the designated color are cut out as the key source signal. When this button is lit, the LUM button is off.

You can carry out chroma keying simply, using the auto chroma key function.

LUM (luminance) button: Press this to use a luminance key to cut out the image. When pressed, this button lights, and portions of the foreground image are cut out based on the luminance level. When this button is lit, the CRK button is off.

Control Panel

MASK button: Press this button to mask off a part of the key source signal. When you press this button, it lights, and the system is now in mask mode, and you can select a rectangular mask in the effect control section. Normally, the area outside the mask rectangle is the area which is masked. To invert the mask, so that the area inside the rectangle is masked, set INVERT (F5) to ON in the effect control section.

Press the button once more to turn it off and end mask mode.

2 DSK (downstream keyer) section

Using a downstream key, you can add characters or graphics to an image to which an effect has already been applied. Unlike a title key, you can add this to an image with a foreground and background superimposed. To insert a downstream key, press the DSK button in the fade-to-black and DSK section.

LUM (luminance) button: Press this to display a menu in the effect control section for adding a key based on the luminance level of an input signal. In the effect control section you can select the input signal to the DSK KEY IN connector on the rear panel or the input signal selected by the DSK FILL button in the delegation section as the key source signal.

BORDER button: Press this button to apply a border to the characters and graphics inserted as a downstream key. When you press this button, it lights, and you can adjust the border settings in the effect control section.

Press the button once more to turn it off, and remove the border.

MASK button: Press this button to mask unwanted parts of the characters and graphics inserted as a downstream key. When you press this button, it lights, and the system is now in mask mode, and you can select a rectangular mask in the effect control section. Normally, the area outside the mask rectangle is the area which is masked. To invert the mask, so that the area inside the rectangle is masked, set INVERT (F5) to ON in the effect control section.

Press the button once more to turn it off and end mask mode.

3 EDGE section

This controls the edge effects applied to the boundary between the foreground and background images.

TRAIL SHADOW button: Press this button to apply a trail, drop border, or shadow effect. When you press this button, it lights, and you can select and adjust the effect in the effect control section.

- **Trail:** The foreground pattern leaves a trail of afterimages.
- **Drop border:** This applies a border in the background of the foreground image.
- **Shadow:** This applies a shadow behind the foreground image.

Press the button once more to turn it off and remove the edge effect.

BEVELD (beveled) EDGE button: Press this button to apply a three-dimensional beveled effect to the boundary between the foreground and background images. When you press this button, it lights, and you can adjust the beveled edge settings in the effect control section.

Press the button once more to turn it off and remove the beveled edge effect.

SOFT button: Press this button to soften the boundary between the foreground and background images. When you press this button, it lights, and you can adjust the degree of softness in the effect control section.

Press the button once more to turn it off and remove the soft edge effect.

BORDER button: Press this button to apply a border to the boundary between the foreground and background images. When you press this button, it lights, and you can adjust the border settings in the effect control section.

Press the button once more to turn it off and remove the border.

Adjusting the cropping: To adjust the cropping, use the second page (CROP) of the adjustment menu for beveled edge, soft edge, or border.

4 CCR, LIGHTING, and MATTES buttons

CCR (color corrector) button: Press this button to use the color corrector. When you press this button, it lights, and you can adjust the color corrector settings in the effect control section. Press the button once more to turn it off and exit the color corrector.

LIGHTING button: Press this button to apply lighting effects to the foreground image. When you press this button, it lights, and you can adjust the lighting settings in the effect control section. Press the button once more to turn it off and remove the lighting effect.

MATTES button: By pressing this button, you can carry out various matte adjustments, matte copies, and internal video signal selections in the effect control section.

5 SHIFT button

When a button in the menu control section is lit, but the corresponding menu is not displayed in the effect control section, hold down the SHIFT button and press the lit button. This brings up the menu, without interrupting the function selection, and leaving the button lit.

This applies to the following buttons:

- MASK buttons in the TITLE section
- BORDER and MASK buttons in the DSK section
- TRAIL SHADOW, BEVELD EDGE, SOFT, and BORDER buttons in the EDGE section
- CCR button and LIGHTING button

6 SET UP button

To access the setup menus for system and control panel settings, press this button. The setup menu appears in the effect control section.

Control Panel

8 Effect control section

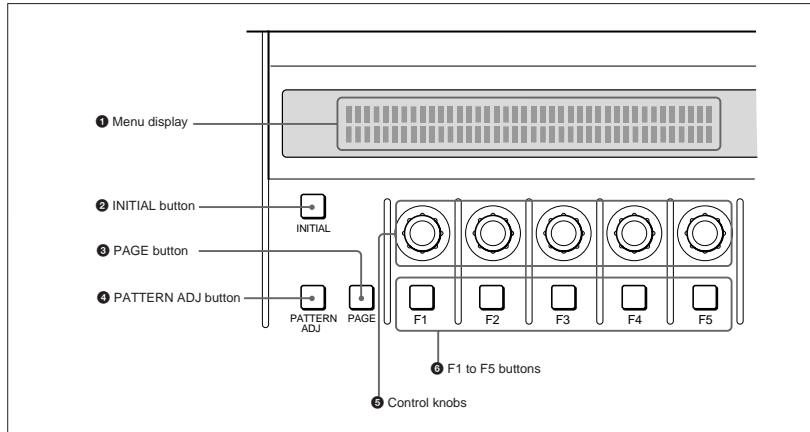

1 Menu display

This shows system and effect settings. Watch this display while checking and adjusting the settings.

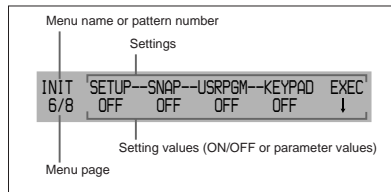

2 INITIAL button

This returns settings to their factory defaults.

- **To return a selected setting to its factory default**
Hold down the INITIAL button, and press the corresponding F button (F1 to F5).

- **To return all settings on the selected page to their factory defaults**

Hold down the INITIAL button, and press the PAGE button.

- **To return all settings on all pages of the currently selected menu to their factory defaults (not valid in setup menu or matte menu)**

Hold down the INITIAL button, and press the PATTERN ADJ button.

3 PAGE button

Press this button to move to the next page of a menu. Pressing this button on the last page of a menu returns to the first page.

Holding down the SHIFT button in the menu control section and pressing this button moves to the previous menu.

4 PATTERN ADJ (adjust) button

Press this button to adjust the settings for the pattern number displayed in the PATTERN NUMBER display window.

This displays the settings for the pattern in the effect control section.

5 Control knobs

These correspond to the five settings shown in the menu display. Turn the corresponding knob to adjust a setting.

6 F1 to F5 buttons

These correspond to the five settings shown in the menu display. Press the corresponding button to select a setting, or toggle it on and off.

- **Changing a setting value preceded by “+” (setup menu operations)**

Hold down the corresponding F button (F1 to F5), and turn the control knob.

- **Changing a setting value followed by “+” (user program effect setting operations)**

Hold down the corresponding F button (F1 to F5), and enter the numeric value using the numeric keypad.

9 User program section

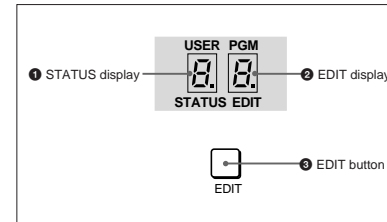

1 STATUS display

When a user program effect is selected, this shows the number of key frames comprising the effect. (Maximum 8)

2 EDIT display

In the user program edit mode, this shows the key frame number to which editing applies.

3 EDIT button

Press this button to edit a user program effect. When you press this button, it lights, and the system enters the user program edit mode.

Press the button once more to turn it off and exit the user program edit mode.

Note

If you press the EDIT button when an effect other than a user program effect is selected, this does not switch to user program edit mode.

10 Snapshot section

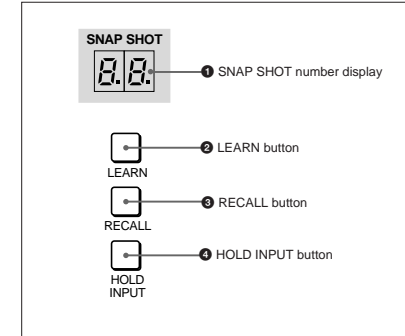

1 SNAP SHOT number display

This shows a snapshot number (0 to 99). While you are entering a number, the dot at the lower right of each numeral lights.

2 LEARN button

Press this button to save the control panel settings as a snapshot (learn function).

When you press this button, it lights, and the system enters learn mode. Enter the snapshot number (0 to 99) from the numeric keypad, and press the ENTER button to save the control panel settings in the snapshot.

3 RECALL button

Press this button to recall settings saved as a snapshot.

When you press this button, it lights, and the system enters recall mode. Enter the snapshot number (0 to 99) from the numeric keypad, and press the ENTER button to recreate the control panel settings from the snapshot on the control panel.

Control Panel

4 HOLD INPUT button

To hold the primary cross-point bus settings and the auxiliary bus settings (signal selections) fixed when recalling a snapshot, press this button. When you press this button, it lights, and when you recall a snapshot, the system is in the hold input mode. When you recall a snapshot in this mode, all settings are recreated on the control panel except those relating to the primary cross-point bus and the auxiliary bus. Press the button once more to turn it off and exit the hold input mode.

12 25-pin connector (rear panel)

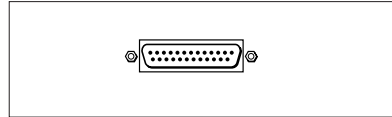

Use the supplied 25-pin control cable to connect this to the PANEL connector on the processor unit.

11 Location section

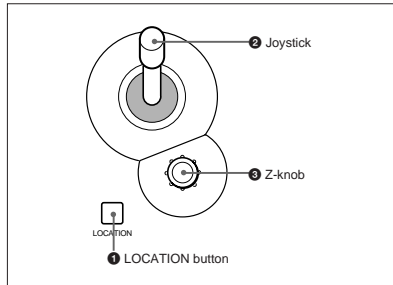

1 LOCATION button

Press this button to use the joystick and Z-knob. When you press this button, it lights, and enables the joystick and Z-knob. Press the button once more to disable the joystick and Z-knob, and return the effect pattern to its default position. Holding down the INITIAL button while pressing this button returns the setting to its default value.

2 Joystick

Use the joystick to position the effect pattern in the x- and y-directions.

3 Z-knob

Turn the Z-knob to move an effect pattern in the depth direction (the z-axis). With this you can change the effective size of the pattern.

Processor Unit

Front Panel

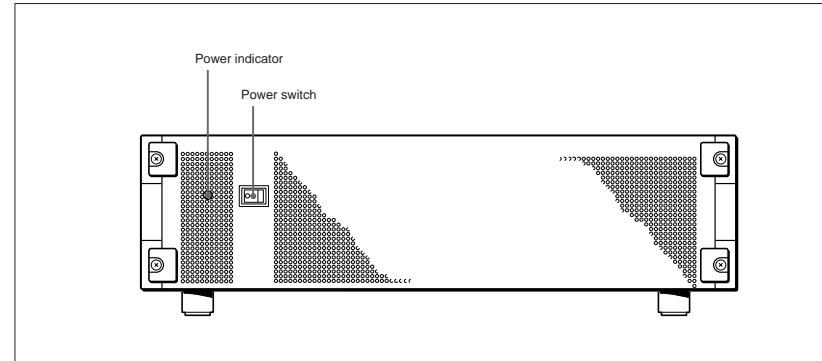

Power switch and indicator

This powers the unit on and off. Press the “I” side of the switch to power on, and the “O” side to power off. When the power is on, the power indicator lights amber.

Rear Panel

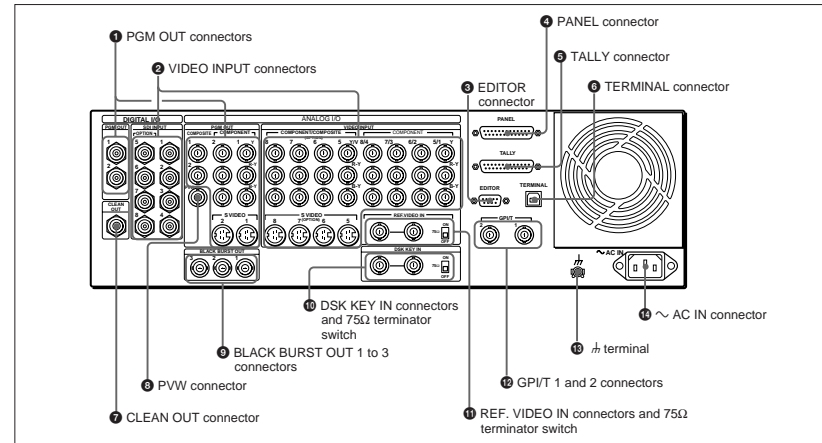

Processor Unit

❶ PGM OUT (program output) connectors

These output the final program output, that is, the video to which effects have been applied. Connect to VTR (recorder) and program monitor video input connectors. The following four types of output are provided, each with two channels (1 and 2).

SDI (BNC): Output serial digital signals (270 MHz).

COMPOSITE (BNC): Output composite video signals.

COMPONENT (BNC): Output Betacam format component video signals (Y, R-Y, B-Y).

S VIDEO (4-pin): Output S-video (Y/C separation) signals.

You can use all four formats simultaneously. The same signals are output from connectors 1 and 2.

❷ VIDEO INPUT connectors

These input video camera and VTR (player) video signals. The connectors are in four groups, as follows.

- SDI INPUT 1 to 4, (OPTION) 5 to 8 (BNC)
- COMPONENT 5/1, 6/2, 7/3, 8/4 (BNC)
- COMPONENT/COMPOSITE (OPTION) 5 to 8 (BNC)
- S VIDEO (OPTION) 5 to 8 (4-pin)

SDI INPUT 1 to 4, (OPTION) 5 to 8 (BNC-type)

Input serial digital signals (270 MHz).

Connectors 5 to 8 can only be used when the optional BKDF-701 SDI and Component Input Board is installed.

The input signals to these connectors must be synchronized to this unit.

COMPONENT 5/1, 6/2, 7/3, 8/4 (BNC-type)

Input Betacam format component video signals.

Y: Input the luminance (Y) signal.

R-Y: Input the R-Y color difference signal.

B-Y: Input the B-Y color difference signal.

The input signals to these connectors must be synchronized to this unit. Therefore, when inputting from a VTR, the signal must come through a time base corrector.

The 8/4 column of connectors can be changed to RGB input connectors by a setup menu operation. In this case, connect G (with sync), R, and B signals to Y, R-Y, and B-Y respectively.

When the optional BKDF-702/702P Y/C and Composite Input Board is installed, you can select in the setup menu whether to use the 5/1, 6/2, 7/3, and 8/4 connectors for component inputs 5 to 8 or component inputs 1 to 4.

COMPONENT/COMPOSITE (OPTION) 5 to 8 (BNC-type)

These connectors can be used by installing either of the optional BKDF-701 and BKDF-702/702P boards.

When the BKDF-701 board is installed, connect Betacam format component video signals. When the BKDF-702/702P board is installed, connect composite video signals. The signals can be input from a VTR with no time base corrector. When using the BKDF-701 to input signals from a VTR, they must come through a time base corrector.

Connector	Input signal for BKDF-701	Input signal for BKDF-702/702P
Y/Y	Luminance (Y) signal	Composite signal
R-Y	Color difference signal (R-Y)	Not used
B-Y	Color difference signal (B-Y)	Not used

S VIDEO (OPTION) 5 to 8 (4-pin)

Input S-video (Y/C separation) signals. These connectors can only be used when the optional BKDF-702/702P board is installed. The signals can be input from a VTR with no time base corrector.

❸ EDITOR connector (9-pin)

Use this connector when controlling this unit with an editor (PVE-500, BVE-2000 series, or other editing control unit). Using an optional 9-pin remote control cable, connect to the 9-pin control connector of the editor.

❹ PANEL connector (25-pin)

With the supplied 25-pin control cable, connect to the 25-pin connector of the control panel.

❺ TALLY connector (25-pin)

Tally signals are output from this connector when the signal input to a VIDEO INPUT connector is selected on the control panel. Connect to the input signal sources (video cameras etc.). The outputs are relay contact signals, with a capacity of 200 mA / 30 V.

❻ TERMINAL connector (USB type B)

This is a USB interface connector. Use it when connecting to a computer for a software version upgrade.

❼ CLEAN OUT connector (BNC-type)

Outputs serial digital signals (270 MHz). Using the setup menu, you can select the output from the following three signals.

CLEAN OUT: The program output signal, without the downstream key inserted.

PVW OUT: The signal output is the same as the program output after completion of the effect transition. The title area can also be shown.

KEY OUT: This outputs a key signal corresponding to the shape of a selected effect. Use it as the key source input to another device.

❽ PVW (preview) connector (BNC-type)

This is an analog composite preview output. The signal output is the same as the program output after completion of the effect transition. It is not possible to include the title area.

❾ BLACK BURST OUT 1 to 3 connectors (BNC-type)

These output the black burst signals generated by the synchronizing signal generator internal to this unit. When an external synchronizing signal is input to the REF. VIDEO IN connectors, the black burst signal output is locked to the external synchronizing signal. Use the output from these connectors as a reference synchronizing signal when synchronizing input signal sources (character generators, etc.), or when synchronizing this unit with a VTR or editor to improve the precision of editing.

❿ DSK (downstream keyer) KEY IN connectors (BNC-type) and 75 Ω terminator switch

Input the key source signal for a downstream key, from a character generator or other device.

When the 75 Ω terminator switch is in the OFF position, the connectors provide a loop-through connection; with the key signal input to one connector, the other provides the same key source signal to another device. By connecting to an analog component Y connector on this unit, you can use it as a title key source.

When not using the loop-through output, the 75 Ω terminator switch must be in the ON position.

⓫ REF. (reference) VIDEO IN connectors (BNC-type) and 75Ω terminator switch

When using this unit synchronized to an external signal, input the external reference signal (black burst). When the 75Ω terminator switch is in the OFF position, the connectors provide a loop-through connection; with the reference signal input to one connector, the other provides the same reference signal for another device. When not using the loop-through output, the 75Ω terminator switch must be in the ON position.

⓬ GPI/T (GPI/trigger) 1 and 2 connectors (BNC-type)

Input external trigger signals. These are used when controlling editing with GPI signals or an editor (BVE-600).

⓭ ♂ (ground) terminal

Connect this to ground as required.

⓮ ~ AC IN connector

With the supplied power cord, connect to the AC supply.

Basic Operation

DME Switcher Introduction

This section selects two of the many effects provided by the DFS-700/700P as examples, and describes the basic flow of operations to use them. It also describes the demonstration function, which automatically executes one hundred sample effects.

Sequence of Operations

The flow charts below show the general sequence of operations when using a DME switcher.

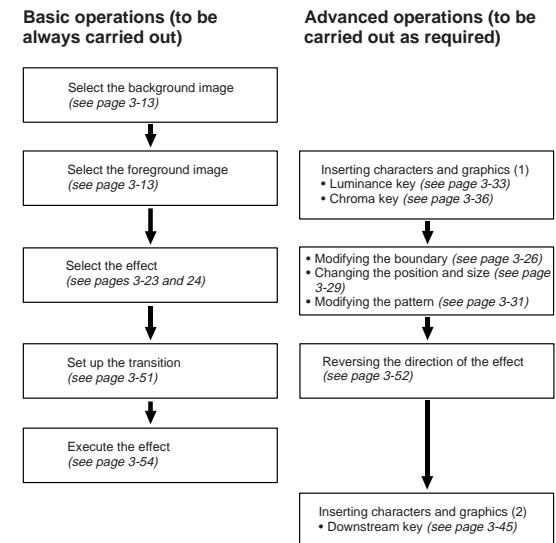

DME Switcher Introduction

Example Operation (1): Wipe

In this example we'll use the AUTO TRANS button, to make a wipe, with the new image appearing from the center of the screen.

Setting items

As an example, we'll set the control panel as follows.

Background image (the image output before the transition): video signal connected to the VIDEO INPUT 1 connector

Foreground image (the image output after the transition): video signal connected to the VIDEO INPUT 2 connector

Effect: wipe (pattern number 24)

Transition time: 30 frames

Program output

Executing the above effect produces the following changes in the output on a program monitor connected to the PGM OUT connector of the processor unit.

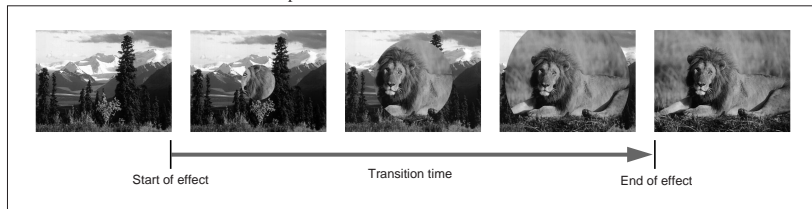

Procedure

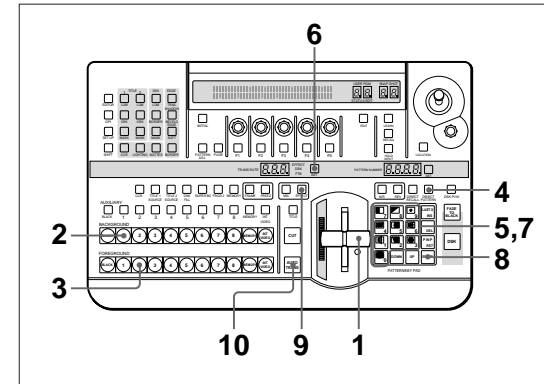

<Preparation>

- 1 Pull the fader lever toward you as far as it will go.

<Image selection>

- 2 Press BACKGROUND Bus button 1.

The pressed button lights red, and the video signal connected to the VIDEO INPUT 1 connector is selected as the background image. The selected background image appears on the program monitor.

- 3 Press FOREGROUND Bus button 2.

The pressed button lights amber, and the video signal connected to the VIDEO INPUT 2 connector is selected as the foreground image. To check the selected image on the program monitor, move the fader lever to the opposite end. After checking, return the lever to the position closest to you.

If a preview monitor is connected, the selected foreground image appears in the preview monitor.

<Effect selection>

- 4 Press the DIRECT PATTERN button, turning it on. (If it is already lit, omit this step.)

The unit is now in direct pattern selection mode. In this mode, you can select the eleven patterns assigned to buttons in the pattern/numeric keypad using the corresponding button.

(Continued)

DME Switcher Introduction

<Transition time setting>

- 5 Press button 9 in the pattern/numeric keypad.

The button lights, and this selects the wipe assigned to this button (pattern number 24). The PATTERN NUMBER display window shows "0024".

- 6 Press the SET button once or twice, so that the EFFECT display window mode indicator lights. (If it is already lit, omit this step.)

- 7 In the pattern/numeric keypad, press buttons 3 and 0 in that order.

The TRANS RATE display window shows ".3.0."

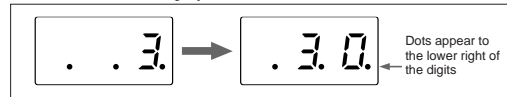

- 8 Press the ENTER button.

The dots to the lower right of the digits disappear, and the value entered in step 7 is set as the transition time.

- 9 Press the EFFECT button, turning it on. (If it is already lit, omit this step.)

- 10 Press the AUTO TRANS button.

The wipe is carried out over 30 frames, switching from the background image to the foreground image.

When the transition completes, BACKGROUND bus button 2 is lit red, and FOREGROUND bus button 1 is lit amber. This indicates that as a result of the transition, the video signal connected to the VIDEO INPUT 2 connector is automatically selected as the background image, and the video signal connected to the VIDEO INPUT 1 connector as the foreground image.

Example Operation (2): Picture-in-Picture

Using the fader lever, we'll insert the foreground image within the background image. We'll apply a border around the edge of the foreground image.

Setting items

As an example, we'll set the control panel as follows.

Background image: internal video signal (color background)

Foreground image: video signal connected to the VIDEO INPUT 1 connector

Effect: picture-in-picture (pattern number 1100)

Border: ON

Program output

Executing the above effect produces the following changes in the output on a program monitor.

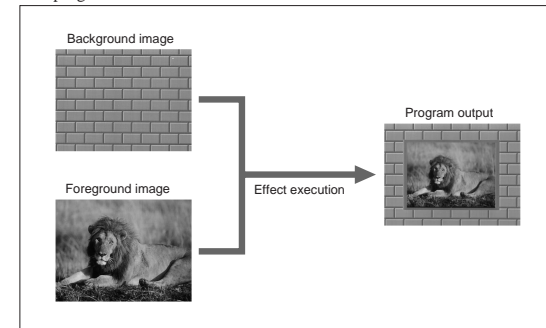

DME Switcher Introduction

Procedure

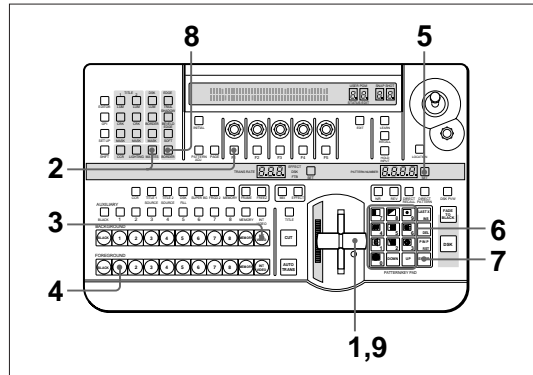

<Preparation>

<Image selection>

- 1 Pull the fader lever toward you as far as it will go.
- 2 Press the MATTE button in the menu control section, and display page 1 of the MATTE menu, then with the F1(SELECT) button select "INT V".

MATTE	SELECT	Lum	Sat	Hue	CH2BRD
1/2	INT V	0-100	0-100	0-99	BRDMAT
PAGE	F1	F2	F3	F4	F5

You can change the color of matte color and embossing pattern. For details, see the section "Adjusting Color Mattes" (page 3-57).

- 3 Press the BACKGROUND bus INT VIDEO button.

The pressed button lights red, and a color matte is selected as the background image.

- 4 Press the FOREGROUND bus button 1.

The pressed button lights amber, and the video signal connected to the VIDEO INPUT 1 connector is selected as the foreground image.

<Effect selection>

- 5 Press the SET button to the right of the PATTERN NUMBER display window, turning it on.
(If it is already lit, omit this step.)

<Border settings>

<Effect execution>

- 6 In the numeric keypad, press buttons 1, 1, 0, 0, in that order.

The TRANS RATE display window shows "1.1.0.0."

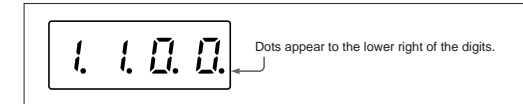

- 7 Press the ENTER button.

The dots to the lower right of the digits disappear, and picture-in-picture, or pattern number 1100, is selected.

- 8 In the menu control section, press the BORDER button.

The button lights, enabling the border.

You can change the color and width of the border. For details, see the section "Modifying the Boundary" (page 3-26).

- 9 Move the fader lever to the opposite end.

Both the BACKGROUND bus INT VIDEO button and the FOREGROUND bus button 1 light red.

As you move the lever, the picture-in-picture effect takes place, and a foreground image with a border is inserted into the background image.

DME Switcher Introduction

Demonstration

The DFS-700/700P is equipped with a demonstration function, which automatically plays back one hundred effects stored in ROM in the processor unit.

The effects (which by factory default are snapshots 0 to 99) have been chosen to demonstrate the features of the DFS-700/700P as effectively as possible.

For maximum effect, the demonstration function uses the signals connected to VIDEO INPUT connectors 1 and 2, and the internal video signal.

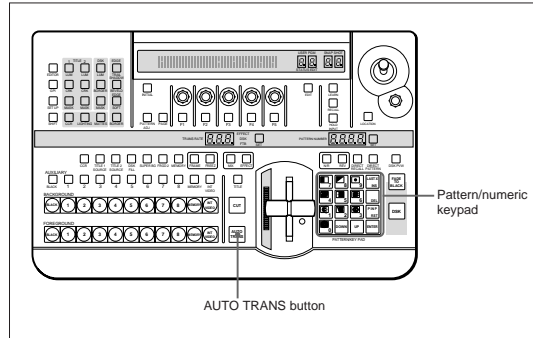

Buttons used for the demonstration

To start the demonstration

In the pattern/numeric keypad, hold down buttons 1 and 9, and press the AUTO TRANS button.

The one hundred effects stored in ROM are played back continuously, and repeated until you press the AUTO TRANS button once more. During the demonstration, the buttons on the pattern/numeric keypad light in turn in the clockwise direction.

During the demonstration, the control panel does not accept any operations other than pressing the AUTO TRANS button.

Demonstration with user-registered snapshots

It is also possible to have a demonstration with user-registered snapshots. In this case, hold down buttons 3 and 7 in the pattern/numeric keypad, and press the AUTO TRANS button. During the demonstration, the buttons on the pattern/numeric keypad light in turn in the counterclockwise direction.

To end the demonstration

Press the AUTO TRANS button once more.

The demonstration ends, and the control panel settings are those of the last effect in the demonstration.

DME Switcher Introduction

Using the Menus

This unit incorporates menus for various effect settings and internal color matte settings, and also a setup menu for system settings. This section describes the basic menu operation.

Accessing a menu

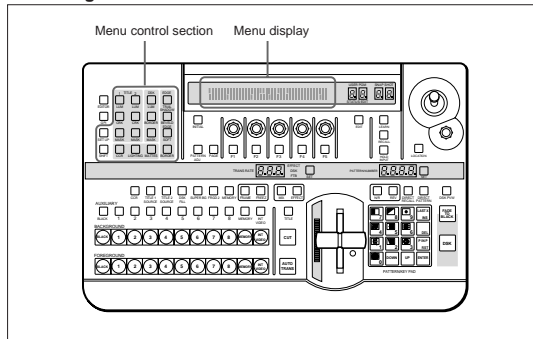

Press one of the buttons in the menu control section. For example, to recall the menu for internal color matte settings, press the MATTE button in the menu control section. The MATTE menu appears in the menu display in the effect control section.

In this manual, menus are shown in a tabular format. The following example shows the MATTE menu.

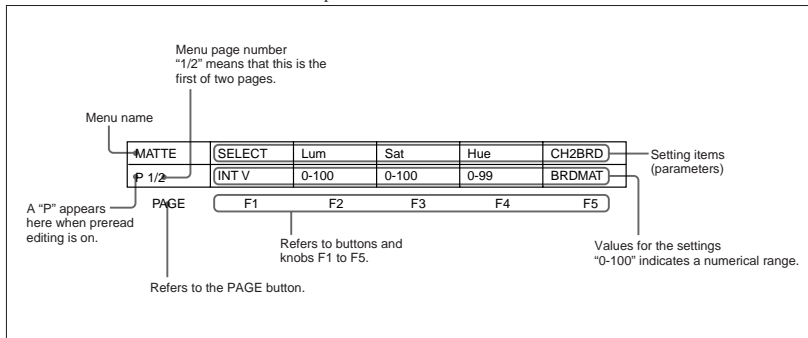

Changing settings

- For settings with values shown in letters, press the corresponding one of buttons F1 to F5.
In the text, this is shown as "the F1(SELECT) button," with the setting name after the button name F1 to F5.
- To change a setting with a numerical value, turn the corresponding one of control knobs F1 to F5.
In the text, this is shown as "the F2(Lum) knob," with the setting name after the knob name F1 to F5.
- In the setup menu, when an item has a plus sign in front, hold down the F button (F4 or F5) and turn the corresponding knob.
For example, in page 3/8 of the setup menu, to change the setting for F4 [+H-pos], hold down the F4 button and turn the F4 knob.

To change the menu page

Press the PAGE button.

Buttons of the menu control section which light when pressed

When you press one of these buttons, it lights, and the settings in the menu recalled by the button are reflected in the monitor display. To avoid this, for example just to check the settings in a menu, hold down the SHIFT button while pressing the menu button.

Selecting Images

Background Image and Foreground Image

Background and foreground in a transition effect

In a transition from one image to another, the old image is referred to as the "background image". The new image, which replaces the old image, is referred to as the "foreground image".

When a transition completes, the background image and foreground image are interchanged.

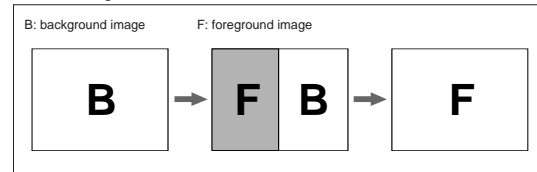

Example transition effect: wipe

Background and foreground in an animation effect

In an animation effect, in which an effect pattern is inserted in the image or moved about on the image, the background image is the background to the effect, and the inserted effect is referred to as the "foreground image".

When an animation effect completes, the background image and foreground image are not interchanged.

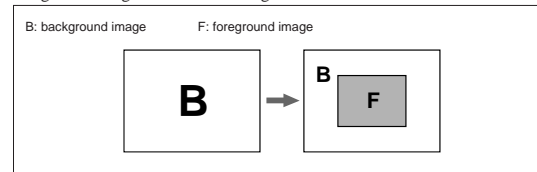

Example animation effect: picture-in-picture

Selecting the background image and foreground image

As the background image and foreground image you can select any of the video signals connected to the VIDEO INPUT 1 to 8 connectors of the processor unit (corresponding to BACKGROUND/FOREGROUND bus buttons 1 to 8), a freeze frame stored in the frame memory (MEMORY button), or internal pattern signal (INT VIDEO button).

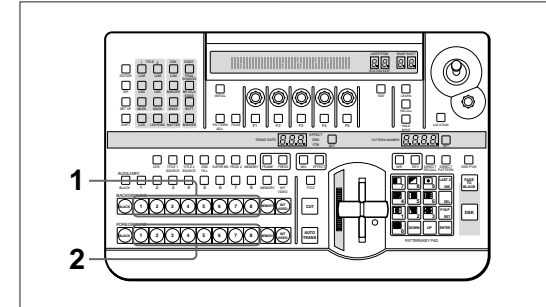

- 1 To select the background image, press one of BACKGROUND bus buttons 1 to 8.

The pressed button lights red.

- 2 To select the foreground image, press one of FOREGROUND bus buttons 1 to 8.

The pressed button lights amber.

Program output and lit button colors

The BACKGROUND bus buttons and FOREGROUND bus buttons light in two colors, depending on whether or not the corresponding image is present in the current program monitor output (on a video monitor connected to the PGM OUT connector).

- **A button lights red** when the image is present in the program monitor output.
- **A button lights amber** when the image is not present in the program monitor output.



Selecting Images

Switching the internal video signal selected by the INT VIDEO button

To switch the internal video signal selected by pressing the INT VIDEO button on either the background bus or foreground bus, use the following procedure.

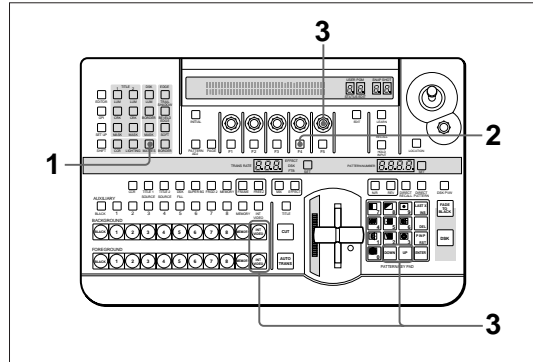

- 1 Press the MATTES button in the menu control section.

Page 1 of the MATTE menu appears.

- 2 Press the PAGE button in the effect control section, to display page 2 of the MATTE menu, then press the F4(INTVID) button to select the desired signal.

MATTE	FROM	TO	COPY	INTVID	PTN
2/2	INT V	BORD	EXEC	Matte	1-80
PAGE	F1	F2	F3	F4	F5

You can select any of the following three possibilities.

Matte: color background signal. In the following step 3, you can select any of plain, or 79 different embossed patterns.

You can adjust the color of the color background signal as desired. For details, see the section "Adjusting Color Mattes" (page 3-57).

Bar: color bars

Grid: a grid pattern

- 3 If you have selected a color background signal carry out either of the following.
 - Hold down the INT VIDEO button in the background bus or foreground bus, and in the pattern/numeric keypad press the UP or DOWN button.
Each time you press, the pattern changes, and the new pattern appears on the program monitor.
 - Turn the F5(PTN) knob.

Previewing the image after an effect is executed

Select the background image and foreground image, and set up the effect, then move the fader lever to the opposite end.

You can now check on the program monitor the result of carrying out the currently set effect.

If a preview monitor is connected, you can check the foreground image on the preview monitor.



Selecting Images

Selecting Signals Output to the Auxiliary Bus

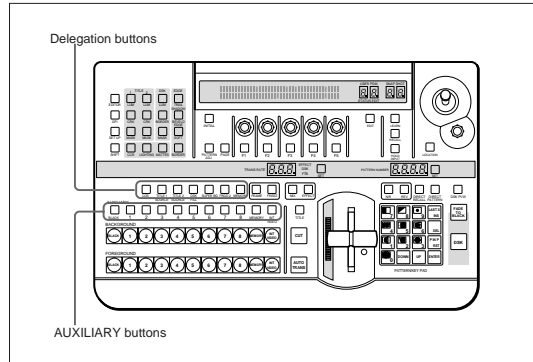

To select the signal to be output to the auxiliary bus, press the desired AUXILIARY button (BLACK, 1 to 8, MEMORY, or INT VIDEO), turning it on.

To specify the function for which the selected signal is used, press one of the delegation buttons, turning it on.

CCR button: use for color correction.

TITLE 1 SOURCE button: use as the key source signal for title key 1.

TITLE 2 SOURCE button: use as the key source signal for title key 2.

DSK FILL button: use as key fill for the downstream keyer.

SUPER BG button: use as background for 3D effects, two-channel DME effects and so on.

FRGD 2 button: use as the second foreground channel for 3D effects, two-channel DME effects and so on.

MEMORY button: capture in frame memory.

Selecting an Effect

This section describes the types of effects you can use on this system, and how to select an effect.

Types of Effect

The DFS-700/700P has more than 450 built-in effect patterns provided as standard.

Each pattern is identified by a number, and the patterns are grouped together under headings such as “wipe” and “picture-in-picture”.

Transition effects and animation effects

Effects are broadly divided into transition effects and animation effects.

Transition effects: in these effects the background image is completely replaced by the foreground image. When the effect completes, the colors in which the BACKGROUND and FOREGROUND bus buttons are lit become the reverse of those before the effect.

Animation effects: in these effects, for example, the foreground image is inserted in the background image, and moved around. The foreground image does not completely replace the background image, and the colors in which the BACKGROUND and FOREGROUND bus buttons are lit stay the same.

For the differences between transition and animation effects, see the section “Background Image and Foreground Image” (page 3-12).

Modifications to effects

Depending on the effect pattern, the following modifications can be added.

- You can add a border to the boundary between the background image and foreground image, or blur the boundary.
- You can change the pattern position and size.

For details of the modifications that can be applied to the effect patterns, see the section “Effect Pattern Variant Forms and Decorations” (page A-22).

- You can change a pattern by changing its parameters. (Effects which can be changed by setting parameters are referred to as “user modifiable effects”.)

Selecting an Effect

Example Effects

This section shows as examples the effect patterns (“direct patterns”) which you can access simply by pressing a button in the pattern/numeric keypad. Note that the effect patterns shown below are the factory default assignments, and you can change the patterns assigned to buttons 0 to 9 and P IN P/RST.

For details of how to change the assignments, see the section “Changing Direct Pattern Assignments” (page 4-1).



Pattern number: 1
Effect type: wipe
Motion type: transition



The foreground image appears from the left, and wipes over the background image to the right.



Pattern number: 9
Effect type: wipe
Motion type: transition



The foreground image appears from the upper left corner, and wipes over the background image to the lower right.



Pattern number: 24
Effect type: wipe
Motion type: transition



The foreground image appears as a circle in the center of the image, and this circle grows, wiping over the background image.



Pattern number: 700
Effect type: matrix wipe
Motion type: transition



The foreground image appears in the upper left corner, and fills the screen in a series of vertical strips.



Pattern number: 1300
Effect type: slide
Motion type: transition



The foreground image appears from the right, and slides over the background image to the left.



Pattern number: 1700
Effect type: 3D rotation
Motion type: transition



The foreground image appears as a door rotating toward the viewer to close, and covers the background. When the door is completely closed, the foreground fills the screen.



Pattern number: 1902
Effect type: flip
Motion type: transition



The image rotates about a vertical axis as though a panel with the background on one side. When the panel reaches 90 degrees to the plane of the screen, the foreground image appears on the other side, and completely fills the screen when the transition ends.



Selecting an Effect



Pattern number: 2100
Effect type: page turn
Motion type: transition



The foreground image appears as though progressively covering the background image.



Pattern number: 2200
Effect type: sphere
Motion type: transition



The foreground image appears in a ball shape in the upper right. It “bounces” on the bottom of the screen, then when it reaches the top, turns into a plane and fills the screen, covering the background image.



Pattern number: 1100
Effect type: picture-in-picture
Motion type: animation



The foreground image appears in the center as a rectangle, of the same aspect ratio as the screen, and grows larger until it covers the background image.



Pattern number: 2260
Effect type: ripple
Motion type: transition

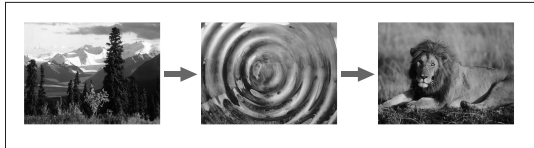

The foreground image appears as from within the ripples, finally covering the whole screen with no movement.

Nonlinear effects

These effects include effects such as ripples, under names such as lens, burst, explosion, swirl, and rings.

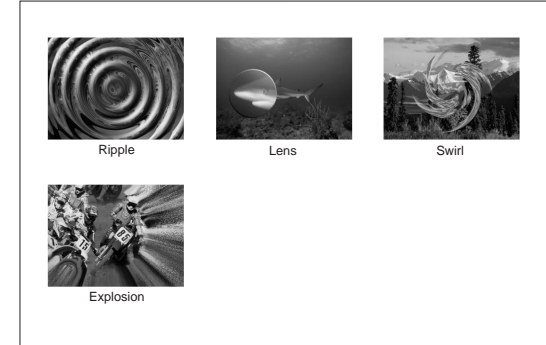

Two-channel DME effects

These effects combine two foreground images with the background image. They include two-channel picture-in-picture, two-picture intersect, two-picture brick, two-channel page turn, and so on.

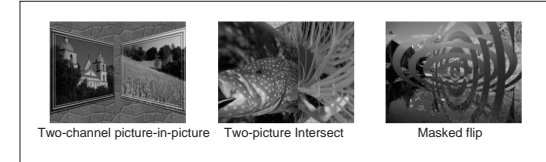

Note

To use two-channel DME effects requires the optional BKDF-711 2nd Channel DME Board.

Selecting an Effect

3D mapping effects

These effects use nonlinear image processing techniques. They include 3D page turn, 3D beveled edge, and so on.

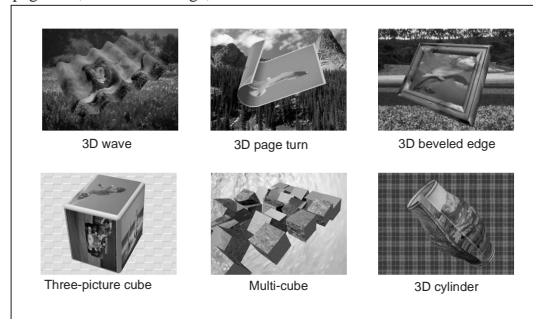

Note

Using 3D mapping effects requires the optional BKDF-712 3D Video Mapping Effects Board.

Using the three-picture cube effect also requires the optional BKDF-711 2nd Channel DME Board.

Selection in Direct Pattern Selection Mode

In the direct pattern selection mode, pressing any button (other than INS, DEL, UP, DOWN, or ENTER) in the pattern/numeric keypad directly selects an effect pattern.

For details of the effects assigned by factory default to the buttons in the pattern/numeric keypad, see the previous section "Example Effects" (page 3-18).

Procedure

To select an effect pattern in the direct pattern selection mode, use the following procedure.

Note

If the EDIT button in the user program section (see page 2-11) is lit, first press it, turning it off.

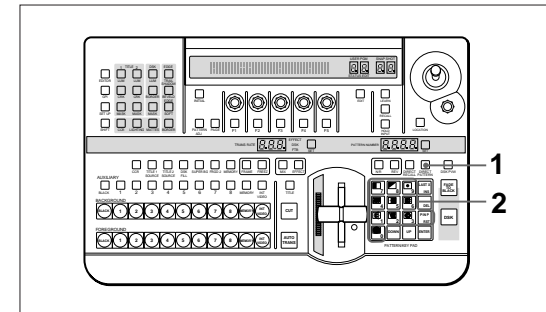

- 1 Press the DIRECT PATTERN button, turning it on.

The unit is now in direct pattern selection mode.

- 2 In the pattern/numeric keypad, press the button assigned to the desired effect pattern, turning it on.

This selects the effect assigned to the button, and the pattern number appears in the PATTERN NUMBER display window.

Selecting an Effect

Selection in Pattern Number Specification Mode

In the pattern number specification mode, you select the desired effect pattern by entering the number.

Procedure

To select an effect pattern in the pattern number specification mode, use the following procedure.

Note

If the EDIT button in the user program section (see page 2-11) is lit, first press it, turning it off.

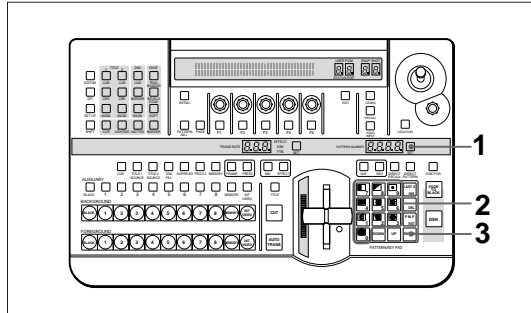

- 1 Press the SET button, turning it on.
- 2 Enter the desired pattern number using buttons 0 to 9 on the pattern/numeric keypad.

The number you entered appears in the PATTERN NUMBER display window. Dots appear at the lower right of each digit, indicating that the entry is not yet confirmed.

- 3 Press the ENTER button.

The dots to the lower right of the digits in the PATTERN NUMBER display window disappear, confirming the pattern number.

If you enter a wrong number

Before pressing the ENTER button press the P IN P/RST button to cancel the wrong number, then enter the correct number.

Note

If you enter an invalid number (a number with no corresponding pattern), this is automatically corrected to the closest valid number larger than the number you entered. However, if you enter a number larger than 9309 this is corrected to pattern number 0001.

Adjusting the number before confirming

To increment the number by one, press the UP button. Hold down the UP button to increase the number continuously.

To decrement the number by one, press the DOWN button. Hold down the DOWN button to decrease the number continuously.

Modifying the Boundary — Border, Soft Edge, Beveled Edge, and Crop

You can apply a border to the boundary between the foreground image and background image, or mask unwanted parts of the image. There are four effects for modifying the boundary, as follows. You can use all four simultaneously.

Border: apply a border to the image boundary.

Soft edge: blur the image boundary.

Beveled edge: apply a bevel to the image boundary.

Crop: adjust the image boundary position, to eliminate unwanted parts. (For picture-in-picture and other effects in which a reduced image is used, reduce noise on the periphery of the image.)

Note

Depending on the effect pattern, you may not be able to apply the above effects. For details, see the section “Effect Pattern Variant Forms and Decorations” (page A-22).

Procedure

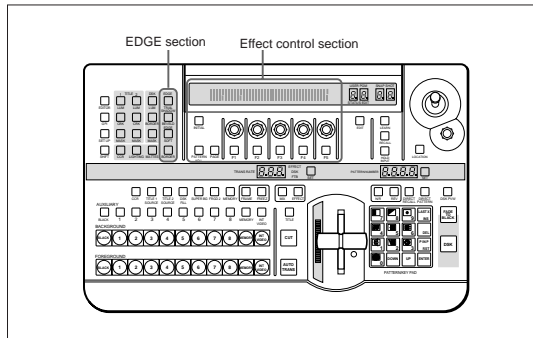

Controls used in modifying the boundary

To apply a border

Use the following procedure.

- 1 Press the BORDER button in the EDGE section, turning it on, and display page 1 of the EDGE menu.

EDGE	Border	Soft	BvWid	BVLTYP	BvInt
1/2	0-100	0-100	-100-100	01-20	0-100
PAGE	F1	F2	F3	F4	F5

- 2 Turn the F1(Border) knob, to set the width of the border.

To blur the image boundary

Use the following procedure.

- 1 Press the SOFT button in the EDGE section, turning it on, and display page 1 of the EDGE menu.

EDGE	Border	Soft	BvWid	BVLTYP	BvInt
1/2	0-100	0-100	-100-100	01-20	0-100
PAGE	F1	F2	F3	F4	F5

- 2 Turn the F2(Soft) knob, to set the degree of boundary blurring.

To apply a beveled edge to the image boundary

Use the following procedure.

- 1 Press the BEVELD EDGE button in the EDGE section, turning it on, and display page 1 of the EDGE menu.

EDGE	Border	Soft	BvWid	BVLTYP	BvInt
1/2	0-100	0-100	-100-100	01-20	0-100
PAGE	F1	F2	F3	F4	F5

- 2 Turn knobs F3(BvWid), F4(BVLTYP), and F5(BvInt) to set the width, type, and contrast of the beveled edge.

To remove unwanted portions of the image

Use the following procedure.

- 1 Press any one of the BORDER, SOFT, and BEVELD EDGE buttons, turning it on, and display page 2 of the EDGE menu. (Press the PAGE button to change the page.)

EDGE	CROP	Left	Right	Top	Bottom
2/2	AUTO	-400-400	-400-400	-300-300	-300-300
PAGE	F1	F2	F3	F4	F5

- 2 To adjust the image boundary manually, press the F1(CROP) button to select “MANUAL”.
- 3 Turn the F2(Left), F3(Right), F4(Top), F5(Bottom) knobs, to adjust the four sides of the image boundary.

Note

If in step 2 you set F1(CROP) to “AUTO”, the automatic adjustment for the particular effect pattern is carried out. Selecting “OFF” disables the cropping.

When effect parameters are already adjusted

When parameters of a border, soft edge, beveled edge, or crop effect are already adjusted, simply pressing any one of the BORDER, SOFT, and BEVELD EDGE buttons in the EDGE section to turn it on allows you to apply the selected effects to the effect pattern.

Modifying the Boundary — Border, Soft Edge, Beveled Edge, and Crop

Indications in the EDGE menu with square brackets []

The parameters in the EDGE menu for functions which are turned off appear in square brackets [].

For example, when the border function is off, when you display the EDGE menu the setting for Border appears in square brackets.

In this state the knob adjustment is still valid.

When you press the BORDER button, turning the function on, the new setting is reflected accordingly.

Changing the Pattern Position and Size — Location (X)(Y)(Z)

You can adjust the position and size of an effect pattern when inserting a foreground image into the background image.

Note

For some effect patterns it is not possible to change their position and size. If pressing the LOCATION button does not turn it on, it means that one of those effect patterns is selected.

For details of whether position and size adjustment is possible for an effect, see the section “Effect Pattern Variant Forms and Decorations” (page A-22).

Procedure

To change the position and size of an effect pattern use the following procedure.

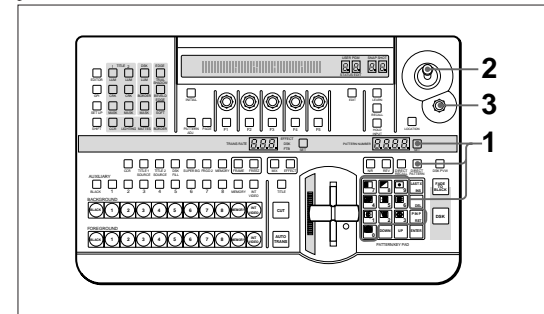

1 After checking in the section “Effect Pattern Variant Forms and Decorations” (page A-22), select an effect pattern for which it is possible to change the position and size.

2 To move the pattern horizontally (x-axis) or vertically (y-axis), move the joystick in the location section.

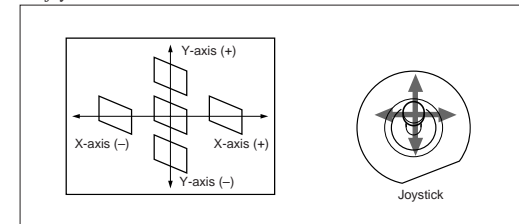

(continued)

Changing the Pattern Position and Size — Location (X)(Y)(Z)

- 3** To move the pattern in the depth direction (z-axis), turn the Z-knob in the location section.

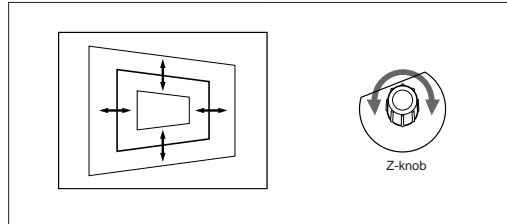

Modifying the Pattern — User Modifiable Effects

User modifiable effects are those effects for which you can modify the effect pattern by varying the parameters. The variable parameters vary from effect to effect.

For the pattern number of user modifiable effects, and the variable parameters, see the section "Effect Control Parameter List" (page A-5)

Procedure

To modify the effect pattern by varying the parameters, use the following procedure.

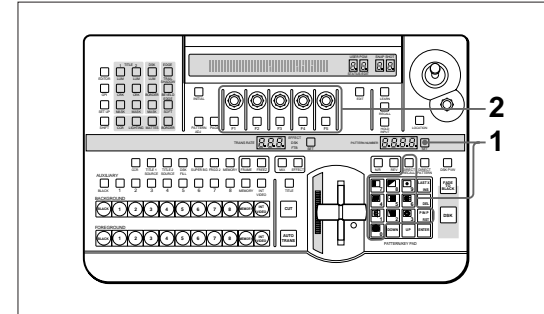

- 1** After checking in the section "Effect Control Parameter List" (page A-5), select a user modifiable effect.

The variable parameters of the selected effect appear in the menu display.

If the selected effect has no variable parameters, the menu display shows a message "No Adjustable Parameter".

- 2** Using knobs and buttons F1 to F5, set the parameters.

Modifying the Pattern — User Modifiable Effects

Example of user modifiable effect parameters

As an example, if you select mosaic (pattern number 1016), the following parameters appear in the menu display.

1016	Size	Aspect	Soft	MskAsp	TYPE
1/1	0-100	0-100	0-100	0-100	FLAT
PAGE	F1	F2	F3	F4	F5

For the effect of the parameters, see the following figure.

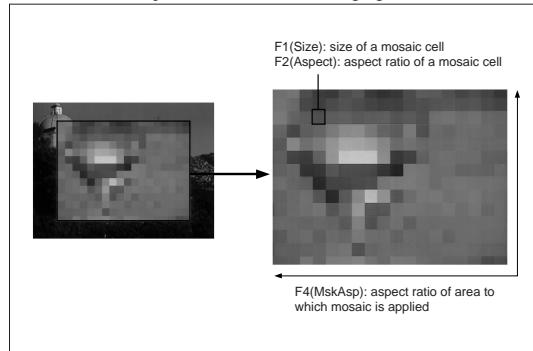

Parameters for mosaic (pattern number 1016)

Inserting Characters and Graphics (1) — Title Key

You can insert (or superimpose) text and graphics into the background image while applying effects. You can use either a luminance key or a chroma key for this insertion.

Luminance Key

In a luminance key, a certain luminance level in the foreground image is used as the threshold for creating the key signal, and the corresponding part of the foreground image is inserted into the background image. Normally the foreground image is on a black background, consisting of bright text to be inserted in the background image.

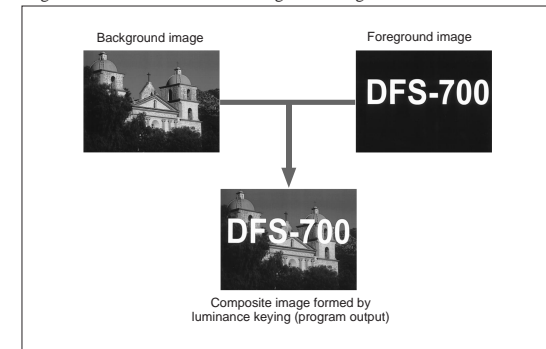

Two-channel luminance keying

With the optional 2nd Channel DME Board installed, you can also use a second luminance key channel.

When using two luminance keys, you must make both title 1 and title 2 settings in the TITLE section of the menu control section. Note that to select the foreground signal used for the second luminance key, in the delegation section press the FRGD 2 button, turning it on, then select the desired video signal with one of the AUXILIARY buttons.

Inserting Characters and Graphics (1) — Title Key

Procedure

To insert text and graphics in a background image by means of a luminance key, use the following procedure.

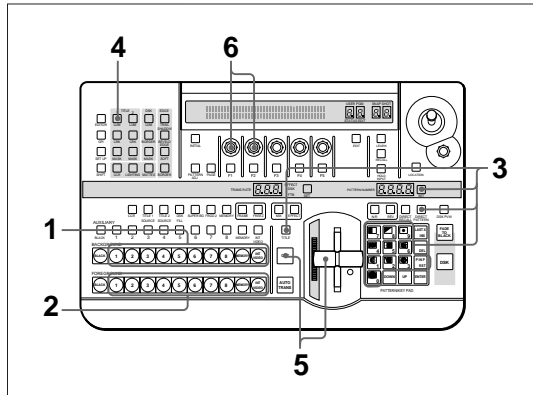

- 1 With the BACKGROUND bus buttons, select the background image.

The selected background image appears on the program monitor.

- 2 With the FOREGROUND bus buttons, select the foreground image.

If a preview monitor is connected, the selected foreground image appears in the preview monitor.

- 3 Select the effect pattern, and press the TITLE button in the effect transition section, turning it on.

Note

Depending on the effect pattern, it may not be possible to use a luminance key. If such a pattern is selected, the TITLE button does not light. Check the "TITLE" column of the table in the section "Effect Pattern Variant Forms and Decorations" (page A-22), and select a pattern for which this shows a check mark (✓).

When the TITLE button lights, the N/R button also automatically lights, indicating that the system is in N/R (normal/reverse) mode. While the TITLE button is lit, it is not possible to switch out of N/R mode.

- 4 In the TITLE section of the menu control section, press a LUM button, turning it on.

The luminance key menu appears in the menu display. In the following example, the LUM button in column 1 is lit.

T1LUM	Clip	Gain	INVERT	FILL	Density
1/1	0-100	0-100	OFF	VIDEO	0-100
PAGE	F1	F2	F3	F4	F5

- 5 Either press the CUT button in the effect transition section, or move the fader lever.

A composite of the foreground and background images appears in the program monitor.

At this point, though, (before adjustment), either of the background image or foreground image may not be visible.

When the foreground image consists of dark lettering on a light background

In the luminance key menu, press the F3(INVERT) button, turning it on, then continue to step 6.

- 6 Watching the composite image on the program monitor, use the F1(Clip) knob and F2(Gain) knob to adjust the clip and gain as necessary.

To switch between the composite image and the background image

Press the CUT button. This toggles between the composite image and the background image.

To fill the inserted text or image with a color matte (using a color matte as key fill)

You can use the same color as a border or the same color as an effect.

- To use the same color as a border, in the luminance key menu, press the F4(FILL) button to select "BDRMAT".
- To use the same color as an effect, in the luminance key menu, press the F4(FILL) button to select "EFFMAT".

To change the color of color mattes, see the section "Adjusting Color Mattes" (page 3-57).

To return from a color matte key fill to the foreground image, press the F4(FILL) button to select "VIDEO".

Creating a composite image with a semi-transparent foreground image

Watching the composite image on the program monitor, turn the F5(Density) knob, to adjust the transparency of the foreground image.

To remove the luminance key

Press the TITLE button in the effect transition section, turning it off.

Inserting Characters and Graphics (1) — Title Key

Chroma Keying

In chroma keying, a key signal is created based on a specific reference color in the foreground image, and used to replace the corresponding parts of the foreground image by the background image. Normally, the foreground image is created with a plain blue background, which is then replaced by the background image.

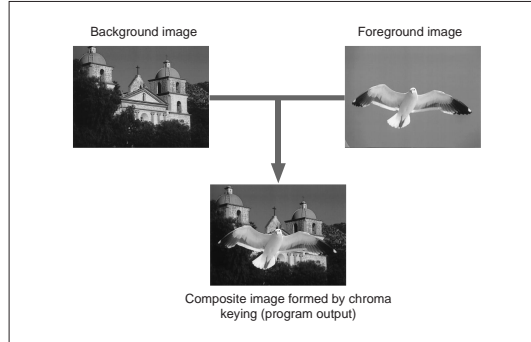

In this system, you can use either of the following methods to carry out chroma keying.

- **Auto chroma keying**

You point the cursor at part of the background, thus specifying the keying color. This is the quick and easy way to make a composite image.

- **Manual chroma keying**

You specify the keying color by manual adjustment. This allows you finer control than with auto chroma keying.

By starting with auto chroma keying, then using manual chroma key adjustments as required, you can get the optimum composite image efficiently.

- **Two-channel chroma keying**

With the optional BKDF-711 2nd Channel DME Board installed, you can use a second chroma key channel.

To use two chroma key channels, set both title 1 and title 2 in the TITLE section of the menu control section. To select the foreground image used for the second chroma key channel, press the FRGD 2 button in the delegation section, turning it on, then with one of the AUXILIARY buttons select the desired video signal.

- **To use a normal effect for a title key**

In this case, use one of the buttons in column 1 of the TITLE section to recall the title 1 setting menu (T1LUM, T1CRK, or T1MSK), and make the settings.

Auto chroma keying

To combine the background image and foreground image by auto chroma keying, use the following procedure.

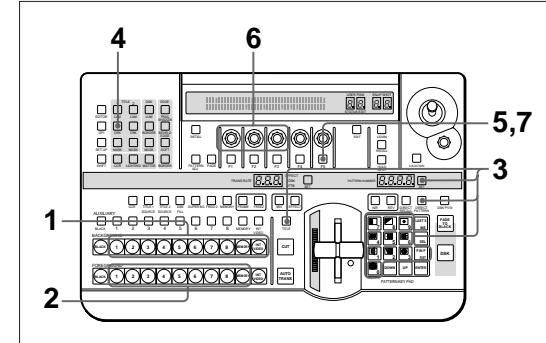

- 1 Select the background image with the BACKGROUND bus buttons.

The selected background image appears on the program monitor.

- 2 Select the foreground image with the FOREGROUND bus buttons.

If a preview monitor is connected, the selected foreground image appears in the preview monitor.

- 3 Select the effect pattern, and press the TITLE button in the effect transition section, turning it on.

Note

Depending on the effect pattern, it may not be possible to use chroma keying. If such a pattern is selected, the TITLE button does not light. Check the "TITLE" column of the table in the section "Effect Pattern Variant Forms and Decorations" (page A-22), and select a pattern for which this shows a check mark (✓).

When the TITLE button lights, the N/R button also automatically lights, indicating that the system is in N/R (normal/reverse) mode. While the TITLE button is lit, it is not possible to switch out of N/R mode.

(continued)

Inserting Characters and Graphics (1) — Title Key

- 4** In the TITLE section of the menu control section, press the CRK button, turning it on.

In the menu display page 1 of the chroma key menu appears. The following example appears when the CRK button in column 1 is lit.

T1CRK	Clip	Gain	Hue	Angle	AUTO
1/3	0-100	0-100	0-99	0-100	↓
PAGE	F1	F2	F3	F4	F5

- 5** Press the F5(AUTO) button.

In the program monitor screen, the foreground image appears with a white box cursor.

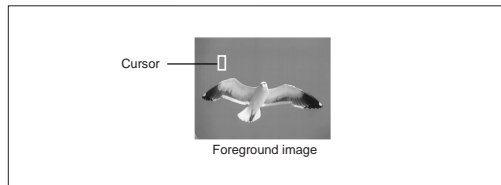

The menu changes to the auto chroma key menu (T1ACR).

T1ACR	Pos H	Pos V	Size	-- AUTO	CRK --
1/1	-100-100	-100-100	0-100	CANCEL	START
PAGE	F1	F2	F3	F4	F5

- 6** Turn the following knobs to adjust the cursor, to select the background color which is used as the reference color for chroma keying.

Cursor adjustment	Control knob
Move horizontally.	F1(Pos H)
Move vertically.	F2(Pos V)
Change the size.	F3(SIZE)

Notes

- You can also adjust the cursor using the joystick and Z-knob in the LOCATION section.
- If you press a button which is not related to auto chroma key operations, this automatically ends the auto chroma key mode.

If there are variations in the background color

Make the cursor as large as possible.

- 7** Press the F5(START) button.

This executes the auto chroma key, and a composite of the background and foreground images appears in the program monitor.

Making fine adjustments to the composite image

Following the manual chroma key procedure (*see next page*), adjust the hue, clip, and gain for the specified chroma key color.

You can also adjust the luminance of the part cut out by the chroma key.

To switch between the composite image and the background image

Press the CUT button. This toggles between the composite image and the background image.

To fill the inserted text or image with a color matte (using a color matte as key fill)

You can use the same color as a border or the same color as an effect.

- To use the same color as a border, in the chroma key menu (T1CRK), press the F4(FILL) button to select "BDRMAT".
- To use the same color as an effect, in the chroma key menu (T1CRK), press the F4(FILL) button to select "EFFMAT".

To change the color of color mattes, see the section "Adjusting Color Mattes" (page 3-57).

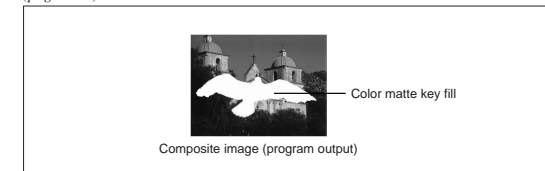

To return from a color matte key fill to the foreground image, in page 2 of the chroma key menu (T1CRK) press the F4(FILL) button to select "VIDEO".



Inserting Characters and Graphics (1) — Title Key

Manual chroma key

To combine the background image and foreground image by manual chroma keying, use the following procedure.

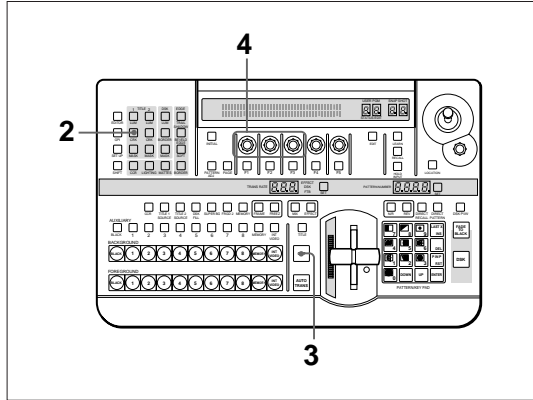

1 Using the same process as in steps **1** to **3** of the procedure for auto chroma keying (see page 3-37), select the background image, foreground image, and effect pattern.

2 In the TITLE section of the menu control section, press the CRK button, turning it on.

In the menu display page 1 of the chroma key menu appears. The following example appears when the CRK button in column 1 is lit.

T1CRK	Clip	Gain	Hue	Angle	AUTO
1/3	0-100	0-100	0-99	0-100	↓
PAGE	F1	F2	F3	F4	F5

3 Press the CUT button in the effect transition section.

A composite of the foreground and background images appears in the program monitor.
At this point, though, (before adjustment), either of the background image or foreground image may not be visible.

4 Watching the composite image on the program monitor, in page 1 of the chroma key menu, adjust the hue, clip, and gain.

When the background part of the foreground image is not completely replaced by the background image
Adjust the hue with the F3(Hue) knob and the clip with the F1(Clip) knob.

When the outline of the foreground image is not clear
Adjust the clip with the F1(Clip) knob and the gain with the F2(Gain) knob.

In combination with a luminance key

1 Press the PAGE button to display page 3 of the chroma key menu, then press the F1(LUM) button, setting the parameter to "ON".

T1CRK	LUM	Clip	Gain	INVERT
3/3	ON	0-100	0-100	OFF
PAGE	F1	F2	F3	F4

2 Watching the composite image on the program monitor, use the F2(Clip) knob to adjust the clip, and the F3(Gain) knob to adjust the gain. To leave dark portions, press the F4(INVERT) button, setting the parameter to "ON".

To switch between the composite image and the background image

Press the CUT button. This toggles between the composite image and the background image.

To fill the inserted text or image with a color matte (using a color matte as key fill)

Use the same procedure as for an auto chroma key (see page 3-39).

Inserting Characters and Graphics (1) — Title Key

Adjusting the hue range for chroma keying (the “angle” setting)

If there are fluctuations in the background color in the foreground image, it may not be immediately possible to key the background image into the whole of the desired background. In this case, you can correct this by increasing the range of hues (the “angle” setting) used for chroma keying. (This means using a wider-angled sector of the hue circle.)

Angle setting (Example: using a blue background color)

- Increasing the angle increases the range of hues replaced by the background image, including shades of cyan and magenta.
- Decreasing the angle decreases the range of hues replaced by the background image, restricting it to closely-matching blues.

Note

If the foreground image includes a color close to the “background” color in a position not intended to be replaced by the background image, then if you make the hue range too wide this part will also be filled by the background image (key fill).

Eliminating bleeding of colors into the edge of the inserted image (color cancel function)

In a chroma key composite image, on the boundary of the inserted image, the “background” keying color in the foreground image (usually blue) tends to bleed into the boundary with the background image. In this case, by replacing the keying color in the composite image by another color (for example gray), the boundary is made to stand out less. This function is called “color cancel”.

To use the color cancel function, use the following procedure.

- 1 In the TITLE section of the menu control section, press the CRK button, turning it on, and display page 2 of the chroma key menu.

The following example appears when the CRK button in column 1 is lit.

T1CRK	COLCAN	Sat	Hue	FILL	Density
2/3	ON	0-100	0-99	VIDEO	0-100
PAGE	F1	F2	F3	F4	F5

- 2 In the effect transition section, press the TITLE button, turning it on, then press the CUT button.

A composite of the foreground and background images appears in the program monitor.

- 3 Press the F1(COLCAN) button, setting the parameter to “ON”.

- 4 Watching the composite image on the program monitor, turn the F3(Hue) and F2(Sat) knobs, until the boundary between the background image and foreground image provides a natural match of hue and saturation.

Creating a composite image with a semi-transparent foreground image (density function)

You can make the inserted image semi-transparent, and insert it into the background image.

Use the following procedure.

- 1 In the TITLE section of the menu control section, press the CRK button, turning it on, to display page 2 of the chroma key menu.

The following example appears when the CRK button in column 1 is lit.

T1CRK	COLCAN	Sat	Hue	FILL	Density
2/3	ON	0-100	0-99	VIDEO	0-100
PAGE	F1	F2	F3	F4	F5

- 2 Watching the composite image on the program monitor, turn the F5(Density) knob, to adjust the transparency of the inserted image.



Inserting Characters and Graphics (1) — Title Key

Masking Part of a Title Key

You can apply a rectangular mask, to eliminate unwanted parts of the key. The masked part is filled with the background image. This operation is common to luminance and chroma keys.

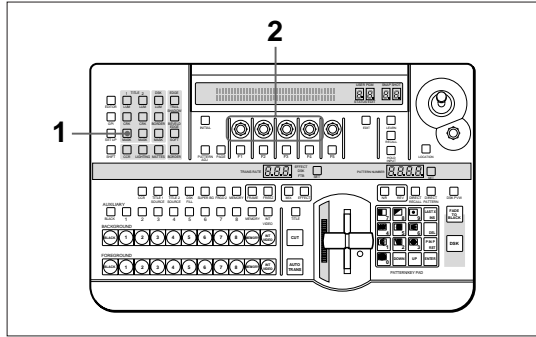

- 1 In the TITLE section of the menu control section, press one of the MASK buttons, turning it on.

The mask menu appears in the menu display. The following example appears when the MASK button in column 1 is lit.

T1MSK	Left	Right	Top	Bottom	INVERT
1/1	-400-400	-400-400	-300-300	-300-300	OFF
PAGE	F1	F2	F3	F4	F5

- 2 Turn the F1(Left), F2(Right), F3(Top), and F4(Bottom) knobs to set the mask region.

Removing the mask

Press the MASK button lit in step 1, turning it off.

To invert the mask

In the mask menu, press the F5(INVERT) button, setting it to "ON".

Inserting Characters and Graphics (2) — Downstream Key

As its name implies, the downstream key (often abbreviated as DSK) is a key which is added downstream the title keying stages, to the already-formed composite image made up of the background and foreground images.

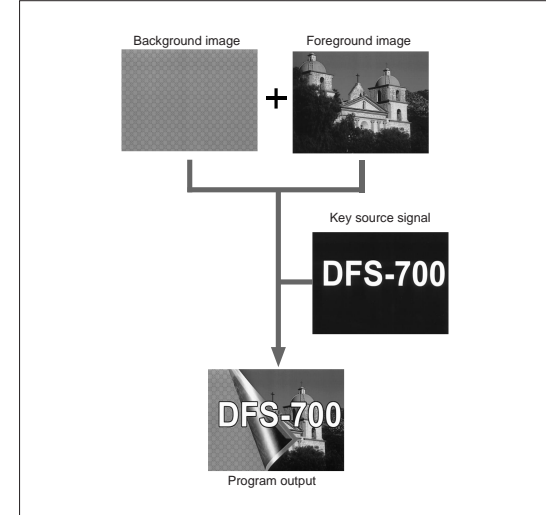

Note that if a preview monitor is connected, you can use it to preview the downstream key on the composite image by pressing the DSK PVW button in the fade-to-black/downstream key section.

Inserting Characters and Graphics (2) — Downstream Key

Procedure

To insert a downstream key, use the following procedure.

For details of key source and key fill signal connections, see the section “Key Signal Connections” (page 6-3).

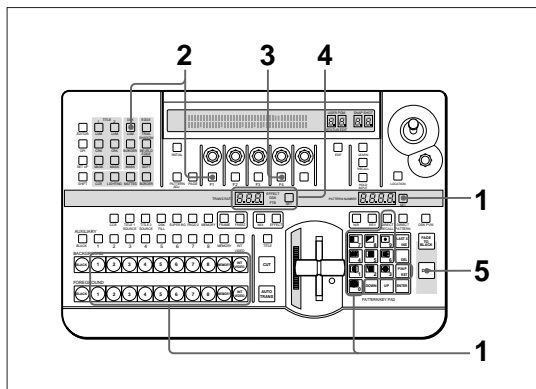

1 First create the image into which the downstream key is to be inserted.

- 1) Select the background and foreground images.
- 2) Select the effect, and create the desired composite image.

2 Select the key source signal for the downstream key.

- 1) In the DSK section of the menu control section, press the LUM button, turning it on, and display page 2 of the downstream key (DSK) menu.

DSK	SOURCE
1/2	EXT
PAGE	F1

- 2) Press the F1(Source) button, and select the signal to be used as the key signal.

EXT: Use the signal input to the DSK KEY IN connector (external key mode).

SELF: Use the signal specified as “DSK FILL” in the delegation section (self-keying mode).

3 Select the downstream key fill signal.

- 1) Press the PAGE button, and switch to page 1 of the downstream key menu.

DSK	Clip	Gain	INVERT	FILL	Density
1/2	0-100	0-100	OFF	VIDEO	0-100
PAGE	F1	F2	F3	F4	F5

- 2) Press the F4(FILL) button, to select the signal used as the key fill signal.

VIDEO: Use the signal specified as “DSK FILL” in the delegation section. When you select this, press the DSK FILL button in the delegation section, turning it on, then select the desired bus with the AUXILIARY buttons.

DSKMAT: Use an internal DSK matte signal.

NONE: Do not use a key fill signal (applying the border only).

Note

When you select “NONE”, DSK border automatically goes on. If you now forcibly turn the DSK border off, the downstream key will not appear.

4 Set the downstream key transition time (the time taken to insert the key).

For an instantaneous insert, set the transition time to zero.

For details of the setting, see the section “Setting the Transition Time” (page 3-51).

5 Press the DSK button to insert the downstream key.

When the downstream key has been inserted, the DSK button lights red.

During the transition, the DSK button lights amber.

Note

Downstream keys are always delayed by 6H.

Deleting the downstream key

When the DSK button is lit red, press it, turning it off.

Adjusting the outline of the downstream key

If the outline of the inserted text or graphics is not sharp, in page 1 of the downstream key menu, adjust the F1(Clip) and F2(Gain) knobs as follows.

- **To adjust the degree to which the key is cut out**, turn the F1(Clip) knob to adjust the clip level.
- **To adjust the sharpness of outline of the key**, turn the F2(Gain) knob to adjust the key gain.

Inserting Characters and Graphics (2) — Downstream Key

To invert the downstream key source signal

Depending on the desired sense of the key source signal (whether the white or black portions form the key), in page 1 of the downstream key menu make the following setting.

- **For white lettering on a black background**, press the F3(INVERT) button, setting it to “OFF”.
- **For black lettering on a white background**, press the F3(INVERT) button, setting it to “ON”.

Applying a border to a downstream key

You can apply a border to the text or graphics inserted as a downstream key, and adjust the border color.

For details of adjusting the border color, see the section “Adjusting Color Mattes” (page 3-57).

To apply a border to a downstream key, use the following procedure.

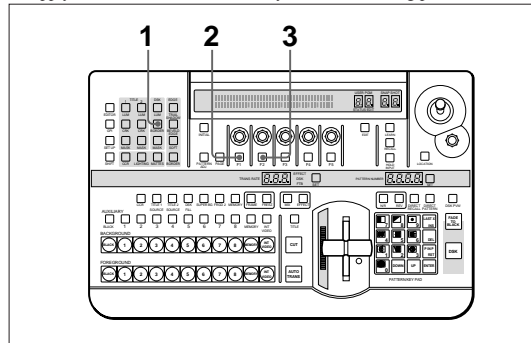

- 1 In the DSK section of the menu control section, press the BORDER button, turning it on.

The downstream key border setting menu (DSK) appears.

DSK	TYPE
1/1	Double

PAGE F1

- 2 Press the F1(TYPE) button, to select the border type.

Wide: wide border

Narrow: narrow border

Drop: drop border

Double: double border (combination of drop and narrow borders)

If you selected drop border or double border, you can now specify the border position with the F2 button.

DSK	TYPE	POS
1/1	Double	T+R

PAGE F1 F2

- 3 If in step 2 you selected drop border or double border, press the F2(POS) button to specify the border position.

Each time you press the button it cycles to the next in the sequence “T+L” (top and left) → “T+R” (top and right) → “B+R” (bottom and right) → “B+L” (bottom and left).

To remove the border

In the DSK section of the menu control section, press the BORDER button, turning it off.

Inserting Characters and Graphics (2) — Downstream Key

To mask a part of the downstream key

You can mask out unwanted portions of a downstream key (text or graphics).

To use the mask function, use the following procedure.

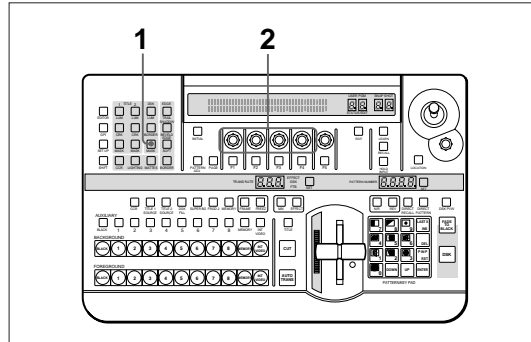

- 1 In the DSK section of the menu control section, press the MASK button, turning it on.

The mask menu (DKMSK) appears in the menu display.

DKMSK	Left	Right	Top	Bottom	INVERT
1/1	-400-400	-400-400	-300-300	-300-300	OFF
PAGE	F1	F2	F3	F4	F5

- 2 Turn the F1(Left), F2(Right), F3(Top), and F4(Bottom) knobs to set the mask region.

Removing the mask

Press the MASK button lit in step 1, turning it off.

To invert the mask

In the mask menu, press the F5(INVERT) button, setting the parameter to "ON".

Setting Up a Transition

This section describes how to set the transition time and transition direction.

Setting the Transition Time

The transition time measures the duration of an effect in frames (1/30 second (NTSC) or 1/25 second (PAL)), ranging from 0 to 999 frames. In this system, you can set the transition time for a downstream key or fade-to-black independently of the transition time for an effect.

Procedure

To set the transition time, use the following procedure.

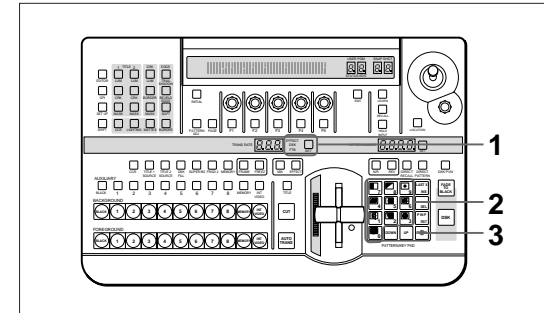

- 1 Press the SET button in the effect transition section until the appropriate display window mode indicator (EFFECT, DSK, or FTB) is lit.

EFFECT: for setting the effect transition time
DSK: for setting the downstream key transition time
FTB: for setting the fade-to-black transition time

Note

If the EDIT button in the user program section is lit, it is not possible to set the transition time. Press the EDIT button, turning it off.

- 2 With buttons 0 to 9 in the pattern/numeric keypad, enter the desired transition time (0 to 999 frames).

The value entered appears in the TRANS RATE display window, and dots appear to the lower right of the digits. You can use the UP and DOWN buttons to adjust the value.

(continued)

Setting Up a Transition

- Press the ENTER button.

The dots to the lower right of the digits disappear, confirming the transition time.

If you make a mistake entering the time

Before pressing the ENTER button press the P IN P/RST button to return the display to the last confirmed value, then enter the correct time.

Setting the Transition Direction

Transition effects are normally executed in the direction in which the foreground image enters (forwards, or "normal"). To reverse the direction, before executing the transition, press the REV button in the effect transition section, turning it on.

Pressing the REV button once more turns it off, and reverts to the normal direction.

If you have selected an animation effect, the N/R button lights, and the normal and reverse directions are used alternately. Each time an effect completes, the REV button goes on or off alternately.

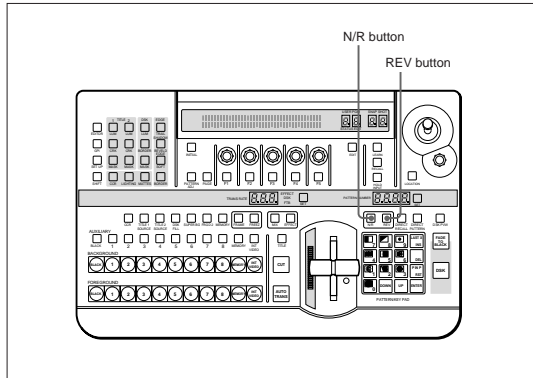

Operation of transition effects

The following figure illustrates the execution of an example transition effect. In the figure, "B" is the background image and "F" the foreground image.

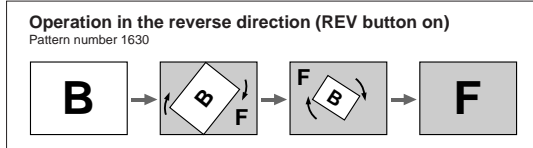
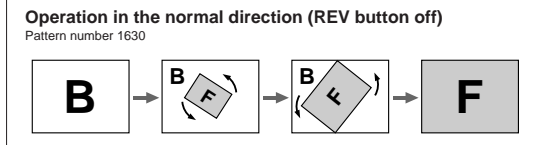

For the direction of operation of other transition effects, see the section "Effect Motion Types" (page A-21).

Operation of animation effects

The following figure illustrates the execution of an example animation effect. In the figure, "B" is the background image and "F" the foreground image.

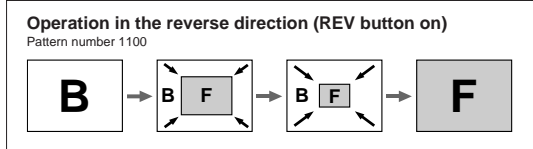
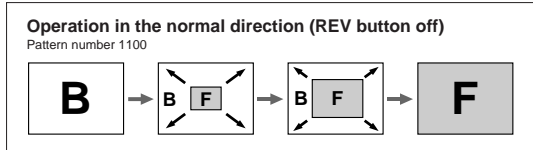

For the direction of operation of other animation effects, see the section "Effect Motion Types" (page A-21).

Executing an Effect

To execute an effect, after setting the execution direction (normal/reverse), in the effect transition section press the AUTO TRANS button, or move the fader lever.

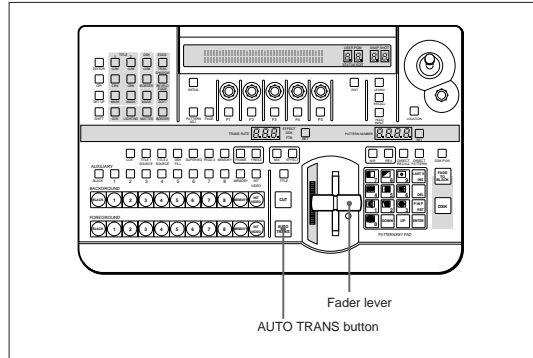

Using the fader lever

By moving the fader lever from one end of its travel to the other at any desired speed, you can manually control the transition. The transition indicator on the left of the fader lever lights progressively corresponding to the status of the transition. When the transition completes, the transition indicator goes completely off. For an effect in which the image switches like a cut, the transition occurs when the fader lever is in the center position.

Note

After powering on the system, move the fader lever once through the whole of its travel. This will ensure that the fader lever operates correctly.

To pause the transition

Stop moving the fader lever.

To resume the transition

Start moving the fader lever again.

Using the AUTO TRANS button

To execute the effect automatically at the preset transition time, press the AUTO TRANS button, turning it on.

To pause the transition

During the transition, press the AUTO TRANS button, turning it off.

Note

If the fader lever is in an intermediate position, then the transition pauses at the corresponding position. To make sure the transition does not pause, first move the fader lever to either end of its travel.

To resume the transition

Press the AUTO TRANS button again.

Using the fader lever and AUTO TRANS button together

You can use the AUTO TRANS button to complete a transition started and paused with the fader lever, or in the opposite way, use the fader lever to complete a transition started and paused with the AUTO TRANS button.

- If you resume a transition partially executed with the fader lever, using the AUTO TRANS button, then the transition time taken is in proportion to the setting for the entire transition. For example, if the transition time is set to 100 frames, and you carry out the equivalent of 25 frames with the fader lever, then press the AUTO TRANS button, the remainder of the transition will take 75 frames.
- If you partially execute the transition with the AUTO TRANS button, then start moving the fader lever, the transition resumes when the fader lever reaches the corresponding intermediate position.

Note

When you carry out an auto transition by controlling the processor unit from an external editor through the EDITOR connector, then regardless of the fader lever position, the transition is executed in its entirety.

Executing an Effect

Checking the direction and state of progress of the transition

Whether you are carrying out the effect manually or automatically, the transition indicator on the left of the fader lever (20 LEDs) shows the state of progress of the transition.

When you start the transition, the indicator lights progressively in the direction of the transition, and goes off when the transition completes. If you pause the transition, the indicator remains on in the corresponding position.

You can always complete a paused transition by moving the fader lever in the direction of the unlit indicator segments.

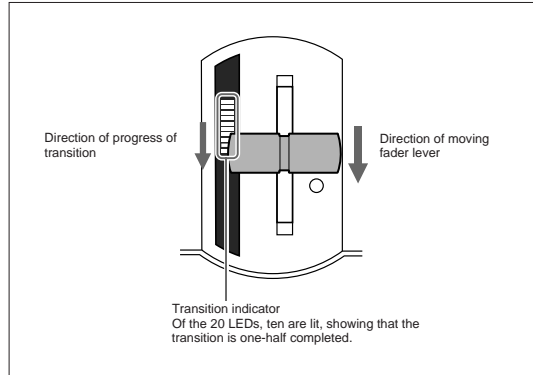

Adjusting Color Mattes

You can adjust the color of each color matte individually, and also copy parameters from other color mattes.

Procedure

To adjust a color matte, use the following procedure.

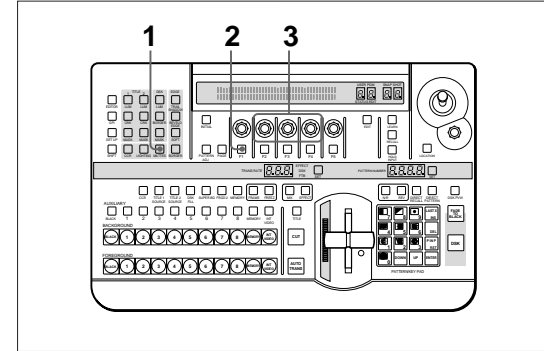

- 1 Press the MATTES button in the menu control section, to display page 1 of the MATTE menu.

MATTE	SELECT	Lum	Sat	Hue	CH2BRD
1/2	INT V	0-100	0-100	0-99	BRDMAT
PAGE	F1	F2	F3	F4	F5

- 2 Press the F1 (SELECT) button, to select the color matte to adjust.

INT V (internal video): color matte used for foreground and background images

BORD (border): color matte used to fill the border applied to an effect pattern, and as key fill for a title key

EFFECT: general-purpose color matte for use in effects

SHADOW: color matte used for shadows around an input image (fill)

DSKFL (DSK fill): color matte used as key fill for a downstream key

DSKBD (DSK border): color matte used for a downstream key border

FTB: color matte used in place of black in the fade-to-black function

- 3 Turn the F2(Lum), F3(Sat), and F4(Hue) knobs, to adjust the luminance, saturation, and hue.

Note

If you vary the luminance of a color matte signal with high saturation, the saturation is automatically adjusted so as not to go outside the signal specifications.

Adjusting Color Mattes

To copy a matte color

To copy the color matte parameters from another color matte, use the following procedure.

- 1 Press the MATTES button in the menu control section, to display page 2 of the MATTE menu. (Press the PAGE button to change pages.)

MATTE	FROM	TO	COPY	INTVID	PTN
2/2	INT V	BORD	EXEC	Matte	1
PAGE	F1	F2	F3	F4	F5

- 2 Press the F1(FROM) button, to select the color matte to be copied.
- 3 Press the F2(TO) button, to select the color matte to which you want to make the copy.
- 4 Press the F3(COPY) button, to carry out the copy.

Adjusting Image Colors — Color Correction

The color correction function allows you to adjust the overall color balance of images, or correct the white balance for different lighting color temperatures.

You can apply color correction to the signal input to any one of the primary input connectors (VIDEO INPUT 1 to 8).

Notes

- Color correction settings cannot be saved in a snapshot.
- The color correction function cannot be used for the effect patterns numbered 2261, 2264, 2267, 2269, and 2279.

Procedure

To adjust the color balance with the color correction function, use the following procedure.

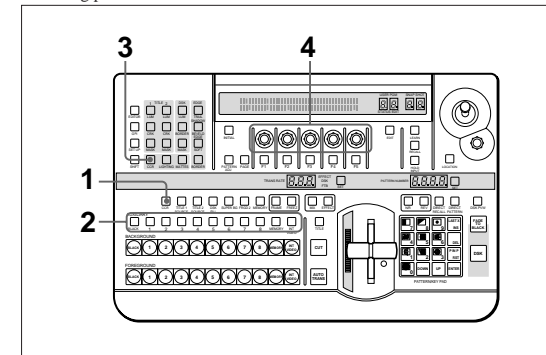

- 1 Press the CCR button in the delegation section, turning it on.
- 2 Press one of the AUXILIARY buttons, turning it on, to select the bus to which the color adjustment applies.
- 3 Press the CCR button in the menu control section, turning it on, to display the color correction menu (CCR).

CCR	Gain	Hue	Offset	HueRot	Gamma
1/1	0-100	0-99	0-100	0-99	0-100
PAGE	F1	F2	F3	F4	F5

(continued)

Adjusting Image Colors — Color Correction

- 4** Watching the image on the monitor, turn the F1 to F5 knobs to adjust the color.

F1(Gain): adjust the chrominance gain (the depth of the colors).

F2(Hue): adjust the hue.

Note

When F3(Offset) is set to its minimum value of zero, turning the F2(Hue) knob has no effect on the hue.

F3(Offset): vary the adjustment range of the F2(Hue) knob.

The larger the value of “Offset,” the wider the range of color adjustment. A smaller value for “Offset” means that the F2(Hue) knob can be used for fine adjustment.

F4(HueRot): set the hue.

F5(Gamma): adjust the gamma value of the luminance signal.

To turn off the color correction function

In the menu control section press the CCR button, turning it off.

Freezing an Input Image — Frame Memory Function

Using the frame memory function, you can capture a “freeze frame” from input video or store a still frame. You can then use this still image as a video source.

Procedure

To capture a freeze frame in memory, use the following procedure.

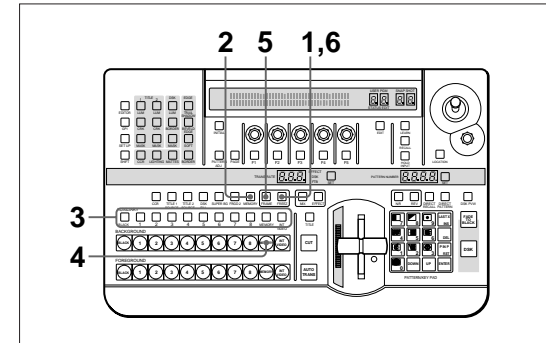

- 1** If the FREEZ button is lit, press it, turning it off.
- 2** In the delegation section press the MEMORY button, turning it on.
- 3** Press one of the AUXILIARY buttons, turning it on, to select the input video signal.
- 4** Press the MEMORY button in the BACKGROUND bus button row, turning it on.
- 5**
 - To capture a frame from still video, press the FRAME button turning it on.
 - To capture a field from moving video, leave the FRAME button off. (Pressing the FRAME button toggles it on and off.)
- 6** Press the FREEZ button, turning it on, to capture the image. (For capture from a moving video input, press the FREEZ button at the point you want to capture.)

The captured image appears on the output bus, and is written to memory.

Note

Even if other than MEMORY is selected on the BACKGROUND bus buttons, you can still capture the selected image with an AUXILIARY button.

Freezing an Input Image — Frame Memory Function

Recalling a freeze frame saved in memory

In the BACKGROUND or FOREGROUND bus button row, press MEMORY, turning it on.

Note

When the unit is powered off, the saved frame is lost from memory.

Fade-to-Black

The fade-to-black allows you to gradually fade the image on the preview monitor (the background image) until it is completely black.

To carry out a fade-to-black

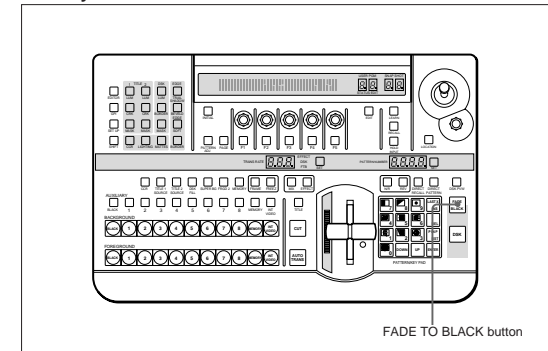

Press the FADE TO BLACK button in the fade-to-black/downstream key section.

During the transition, the FADE TO BLACK button lights amber, and when the transition completes (when the image is completely black), lights red.

To end a fade-to-black

When the FADE TO BLACK button is lit red (the screen is black), press the FADE TO BLACK button. The output gradually changes from black to the image selected on the BACKGROUND bus buttons.

To reverse the direction of a fade-to-black transition during execution

During the transition (while the FADE TO BLACK button is lit amber), press the FADE TO BLACK button.

This immediately reverses the direction of the transition.

Setting the fade-to-black transition time

Follow the procedure in the section "Setting the Transition Time" (page 3-51).

To change the color from black

Follow the procedure in the section "Adjusting Color Mattes" (page 3-57).

To prohibit a fade-to-black

See F4 in the section "Control Panel Setup (page 5/8)" (page 6-10).



Advanced Operations

Changing Direct Pattern Assignments

You can change the effect patterns assigned to the buttons 0 to 9 and P IN P/RST. Doing so allows you to select frequently used patterns simply by pressing the corresponding buttons in direct pattern selection mode.

To change the direct pattern assignment

To change the direct pattern assignment to the buttons 0 to 9 and P IN P/RST, use the following procedure.

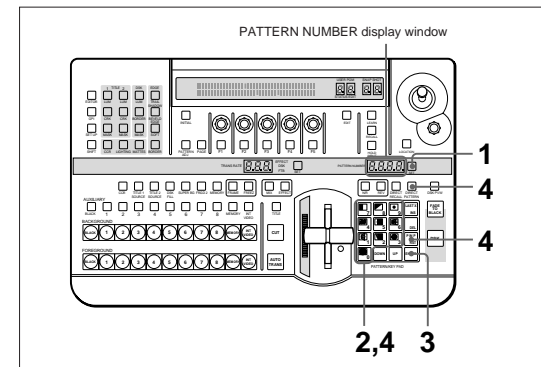

- 1 Press the SET button.

The button lights, and the unit enters pattern number entry mode.

(continued)

Changing Direct Pattern Assignments

- Use buttons 0 to 9 to enter the pattern number you want to assign to a button.

For more information about pattern numbers, see the section “Effect Pattern Image List” (page A-29).

The number you enter appears in the PATTERN NUMBER display window.

- Press the ENTER button.
- While holding down the DIRECT PATTERN button, press the button (0 to 9, or P IN P/RST) to which you want to assign the pattern.

The button you pressed lights, and the pattern number entered in step 2 is assigned to the button.

To restore the default assignments (direct pattern reinitialization)

After changing pattern assignments, you can restore the factory default assignments shown in “Example Effects” (page 3-18).

To return all of the buttons 0 to 9 and P IN P/RST to their factory default assignments, use the following procedure.

- Press the SET UP button.

The setup menu appears.
- Press the PAGE button to display page 6/8.
- Press the F4(KEYPAD) button to set it to “ON”.
- Press the F5(EXEC) button.
- Press the F3(OK) button.

This returns all of the assignments to the 0 to 9 and P IN P/RST buttons to their factory default settings.

User Program Effects

In addition to the internal effect patterns, you can also create user-customized effect patterns. These are referred to as “user program effects.” With standard equipment you can save a maximum of 40 effects. You use these effect patterns in the same way as the internal patterns, using the assigned number.

Constructing a User Program Effect

You build a user program effect from key frames, which show an outline of the animation.

A user effect can consist of up to eight key frames, numbered from 1 to 8. When you execute the effect, it runs through the key frames in sequence, starting from the highest numbered, and ending on key frame 1. Therefore, when creating the effect you save the movement in the reverse direction (with the image selected on the foreground bus moving outside the screen).

By pressing the REVERSE button, turning it on, you can execute the effect in the reverse order of the created key frames. You can adjust the interval between key frames by a menu setting.

When you execute a user program effect, the interval between key frames is automatically interpolated using spline curves, producing a smooth effect. You can also adjust the smoothness of the spline curves (i.e. the movement) when executing the effect.

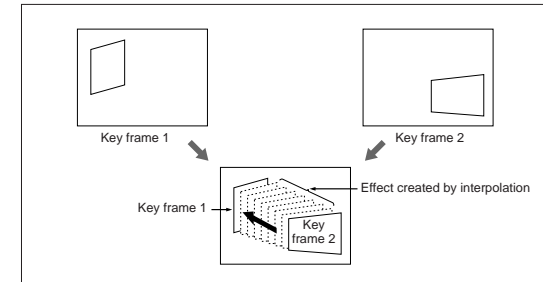

If you execute a user program effect that consists of a single key frame, the result is that the foreground image appears against the background image, subjected only to the effect defined for key frame 1.

User Program Effects

Types of User Program Effect

There are four types of user program effects. The four types must be registered saved in the pattern number ranges shown below.

Effect type		Pattern number
Linear	Transition	9000 to 9009
	Animation	9100 to 9109
Nonlinear	Transition	9200 to 9209
	Animation	9300 to 9309

Linear: effects built from rotation, magnification, and movement of the x-, y-, and z-axes

For details of the modification parameters, see page 4-6.

Nonlinear: modifications of the page turn, page roll, and sphere effects, together with z-axis rotation, magnification, and movement

For details of the modification parameters, see page 4-7.

Transition effects: effects which accomplish a transition from one scene to another. After the effect completes, the background image (B) and foreground image (F) are interchanged.

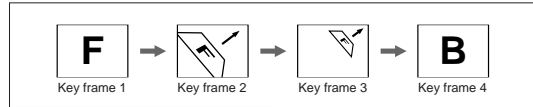

Example of a transition user program effect

When you execute an effect saved as shown above in the “normal” direction (with the REV button off), the key frames go in the sequence from 4 to 1.

Animation effects: effects in which the foreground image (F) remains on the background image (B). You can vary the shape of the foreground image, or move it about the screen.

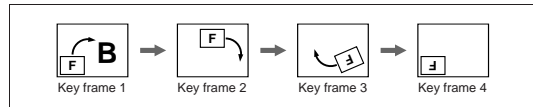

Example of an animation user program effect

When you execute an animation effect saved as shown above in the “normal” direction (with the REV button off), again the key frames go in the sequence from 4 to 1.

Modification Parameters

You can adjust key frames, using the effect control section and location section to set the parameters described on pages 4-6 and 4-7.

- If you specify a linear user program effect number, the following three pages appear in the menu display.

Page 1/3: Rot-X, Rot-Y, Rot-Z, Pers

Page 2/3: Loc-X, Loc-Y, Loc-Z, KfDur

You can control Loc-X, Loc-Y, and Loc-Z from the location section.

Page 3/3: key frame temporary storage

- If you specify a nonlinear user program effect number, the following three pages appear in the menu display.

Page 1/3: Angle, Offset, Rot-Z, Radius, FORM

Page 2/3: Loc-X, Loc-Y, Loc-Z, KfDur

You can control Loc-X, Loc-Y, and Loc-Z from the location section.

Page 3/3: key frame temporary storage

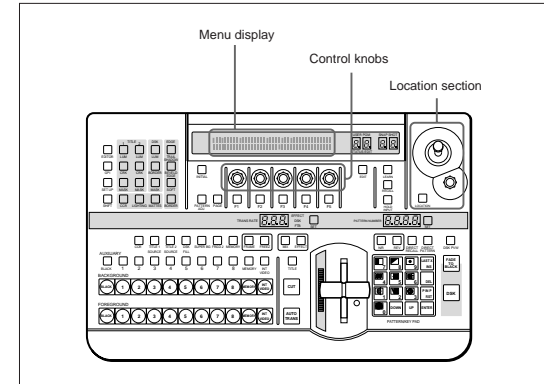

User Program Effects

Parameters for linear user program effects (9000 to 9009 and 9100 to 9109)

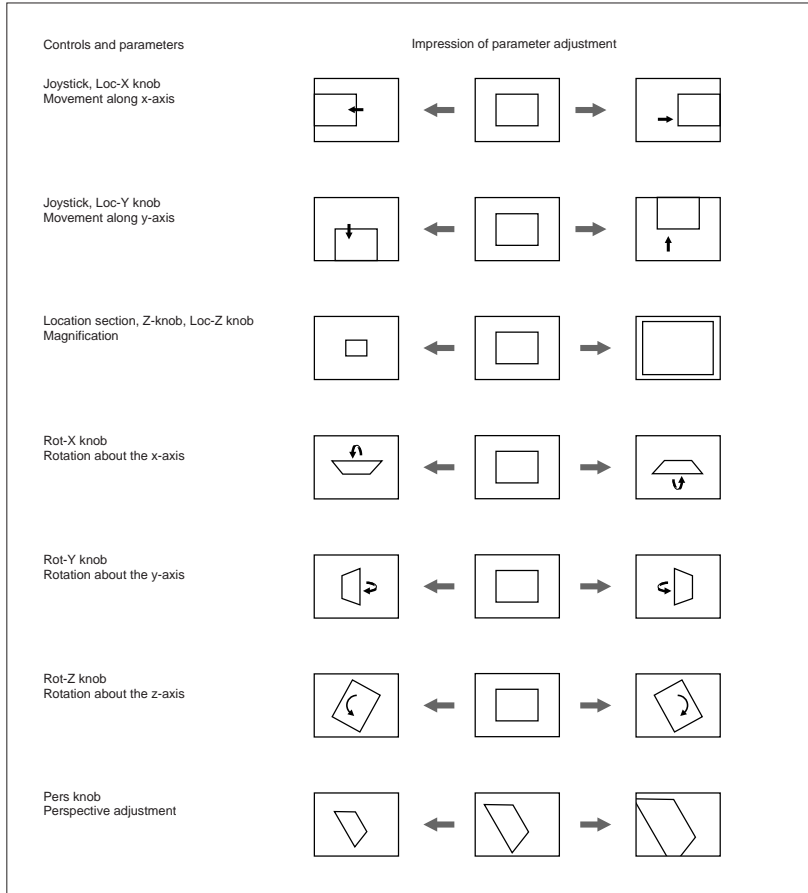

Parameters for nonlinear user program effects (9200 to 9209 and 9300 to 9309)

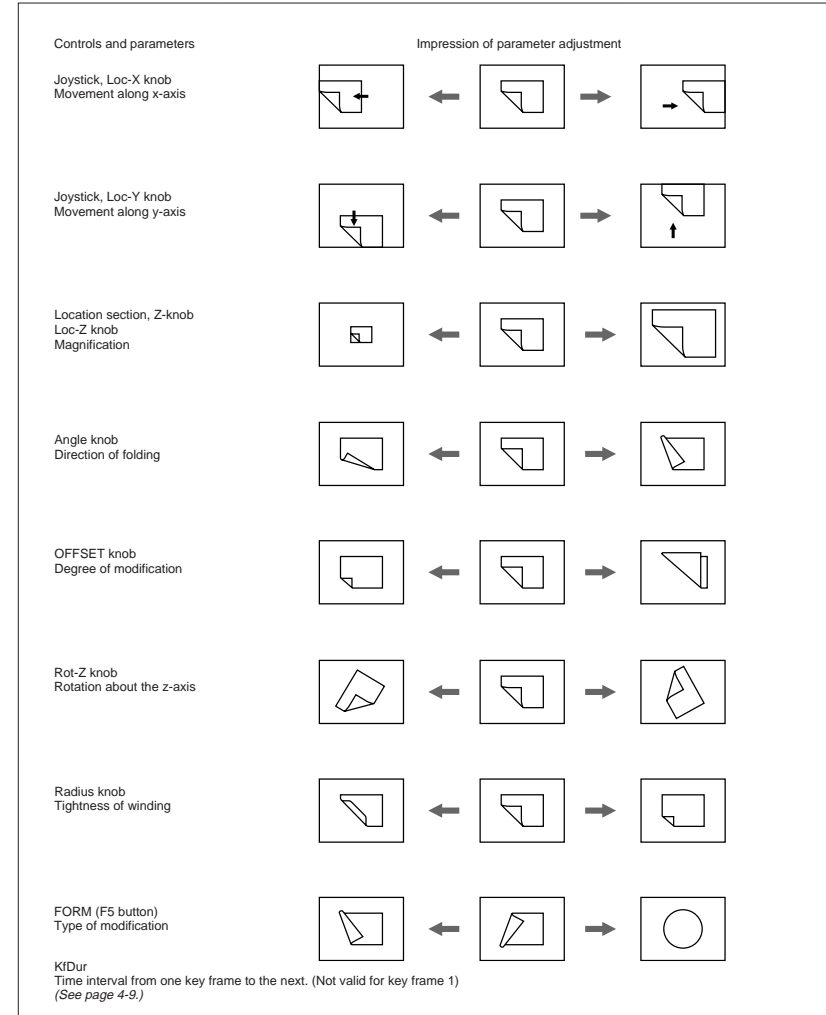

User Program Effects

Displaying parameter values

The numerical values of the parameters appear in the menu.

Numerical parameter values

Parameter	Function	Value range	Default
Loc-X	Movement along x-axis	-800 to +800 ^{a)}	0
Loc-Y	Movement along y-axis	-600 to +600 ^{b)}	0
Loc-Z	Magnification	0 to 200	100
KfDur	Key frame duration	1 to 100	50
Rot-X	Rotation about the x-axis	-400 to +400 ^{c)}	0
Rot-Y	Rotation about the y-axis	-400 to +400 ^{c)}	0
Rot-Z	Rotation about the z-axis	-400 to +400 ^{c)}	0
Pers	Perspective	0 to 400	200
Angle	Direction of folding	-100 to +100 ^{c)}	20
Offset	Degree of modification	0 to 200	0
Rot-Z	Rotation about the z-axis	-400 to +400 ^{c)}	0
Radius	Radius	0 to 100	0
FORM	Type of modification	TURN, ROLL, SPHERE ^{d)}	TURN

- a) 600 corresponds to the full width of the screen.
 b) 300 corresponds to the full height of the screen.
 c) 100 corresponds to 360 degrees.
 d) For SPHERE, the Angle and the Radius parameter do not function.

Resetting the parameters to their initial values

- To reset all of the parameters, hold down the INITIAL button, and press the PATTERN ADJ button.
The initial values of the parameters are for an unmodified image occupying the whole screen.
- To reset all of the parameters on a particular page, hold down the INITIAL button, and press the PAGE button.
- To reset a particular parameter only, press the corresponding function button while holding down the INITIAL button.

About the key frame duration

The KfDur value (key frame duration) for key frame n corresponds to the interval between key frame n and key frame n+1. Therefore, if the settings are as follows:

Key frame 1 ... not effective
Key frame 2 ... KfDur 100
Key frame 3 ... KfDur 50
Key frame 4 ... KfDur 50

The interval between key frames 1 and 2 is twice that between the other pairs of frames. For example, if the transition duration is set to 100 frames, the transition will proceed as follows:

Key frame 4 → **3** ... 25 frames
Key frame 3 → **2** ... 25 frames
Key frame 2 → **1** ... 50 frames

Setting the type of interpolation

When executing the effect, using the F1 button in the menu, you can set the type of interpolation between key frames as follows:

Lin: linear interpolation
S-Lin: S-curve interpolation
Spln: spline interpolation
V-Spln: parameterized spline interpolation

If you select V-Spln, with the F2(Tens) knob you can adjust the tension of the spline curve in the range -100 to +100. This controls the smoothness, with the initial value 0 and -100 giving the smoothest result.

User Program Effects

Creating New User Program Effects

To create a new user program effect, use the following procedure.

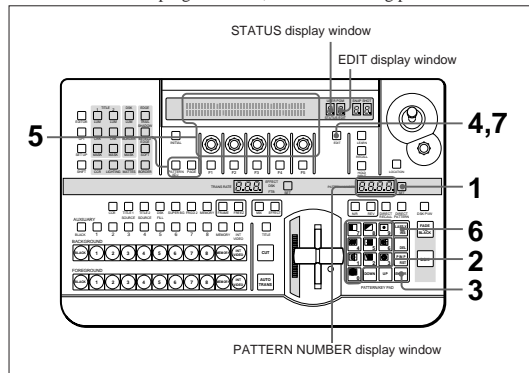

- 1 Press the SET button.
- 2 Using the numeric buttons, enter the pattern number of the user program effect to be created.

If you enter a number outside the user program effect range, an audible warning sounds in step 4. (The warning sounds only if the item BEEPER on page 5 of the setup menu is set to ON.)

Effect type		Pattern number
Linear	Transition	9000 to 9009
	Animation	9100 to 9109
Nonlinear	Transition	9200 to 9209
	Animation	9300 to 9309

The number you entered appears in the PATTERN NUMBER display window.

- 3 Press the ENTER button.

The STATUS display window should show "1". If it shows any value other than "1" this means that there are already a number of key frames assigned to this number.

- 4 Press the EDIT button.

The button lights, the system enters user program edit mode, and the monitor shows the image (key frame 1) selected on the FOREGROUND bus buttons. This is because for a new effect, key frame 1 is saved as an unmodified, full-screen foreground.

- 5 In the menu, set the parameters, and create key frame 2.

When creating a transition effect, see the section "Notes on creating a transition user program effect" below.

- 6 When you have the image you want to save, press the LAST X/INS button.

This creates key frame 2 with the parameters set in step 5, and saves the key frame after key frame 1. A "2" appears in the EDIT display window and STATUS display window.

If this is an animation effect, instead of the LAST X/INS button, you can press the ENTER button to save the key frame created with the parameters set in step 5 as key frame 1 (thus modifying key frame 1). This is because an animation effect is allowed to have key frame 1 different from an unmodified foreground image.

By repeating steps 5 and 6 (making parameter settings and adding key frame with the LAST X/INS button), you can create the required sequence of key frame (maximum eight). The STATUS display window shows the number of saved key frames.

- 7 When you have saved all the required key frames, press the EDIT button once more.

The button goes off, and the created user program effect is now ready to be used.

Notes on creating a transition user program effect

- Make key frame 1 an unmodified full-screen image. (In a new pattern, key frame 1 is automatically saved as a full-screen image.)
- In the last key frame, make the background image completely disappear. (Either make it of zero size, or move it outside the screen area.) This will make the created effect smoother.
- For the linear PERS parameter and the nonlinear FORM parameter, the key frames must all have the same value. The value saved in the last key frame is used for all key frames.

User Program Effects

Editing User Program Effects

You can recall a created user program effect, and change its parameters, or add, delete, or copy key frames.

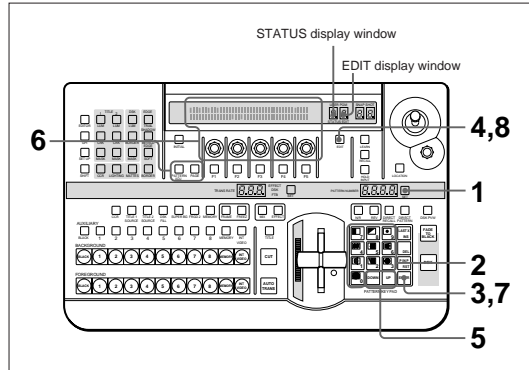

To recall a user program effect

Use the following procedure.

- 1** Press the SET button.
- 2** Use buttons 0 to 9 to enter the user program effect number.

The number you entered appears in the PATTERN NUMBER display window.

- 3** Press the ENTER button.

The STATUS display window shows the number of key frames in the user program effect you specified in step **2**.

- 4** Press the EDIT button.

The button lights, and the editing screen for the user program effect you specified in step **2** (the image selected on the FOREGROUND bus buttons) appears.

The STATUS display window shows the number of key frames saved in the user program effect.

To change the key frame parameters

After carrying out the procedure to step **4** in the section "To recall a user program effect" above, use the following procedure.

- 5** Press the UP or DOWN button in the pattern/numeric keypad, so that the number of the key frame for which you want to change the parameters appears in the EDIT display window.

- 6** Change the parameters in the menu.

- 7** Press the ENTER button.

This saves the changed key frame parameters.

Repeat steps **5**, **6**, and **7**, to change the key frame parameters in all desired key frames in turn.

- 8** When all the changes are made, EDIT button.

The button goes off, and the modified user program effect is resaved.

User Program Effects

Adding a key frame

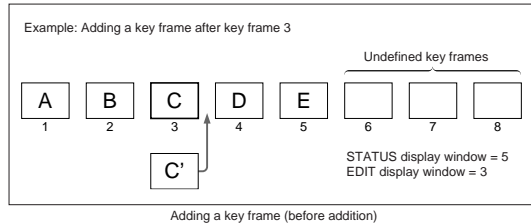

After carrying out the procedure to step 4 in the section “To recall a user program effect” on the page 4-12, use the following procedure.

- 5 Press the UP or DOWN button in the pattern/numeric keypad, so that the number of the key frame before where you want to insert the new frame (key frame 3 in the example above) appears in the EDIT display window.
- 6 Set the parameters in the menu.
- 7 Press the LAST X/INS button.

This inserts a new key frame with the parameters you set in step 6 after the key frame specified in step 5, and the number of key frames shown in the STATUS display window increases by 1.

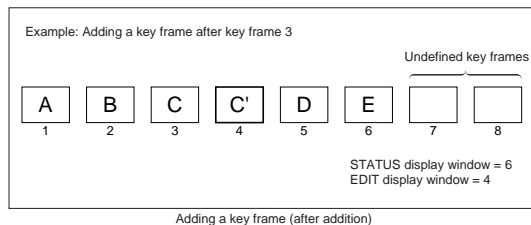

Repeat steps 5 to 7 as required to add more key frames.

Deleting a key frame

- 8 When you have added all the key frames, press the EDIT button.

The button goes off, and the user program effect is resaved with the added key frames.

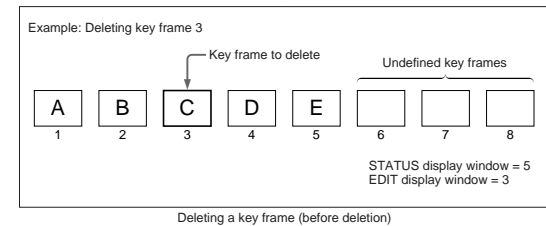

After carrying out the procedure to step 4 in the section “To recall a user program effect” on the page 4-12, use the following procedure.

- 5 Press the UP or DOWN button in the pattern/numeric keypad, so that the number of the key frame you want to delete (key frame 3 in the example above) appears in the EDIT display window.
- 6 Press the DEL button. (To prevent you from inadvertently deleting a key frame, you must hold the button down for at least 0.5 seconds.)

An alarm sounds, and the key frame you specified in step 5 is deleted. The number of key frames shown in the STATUS display window decreases by 1.

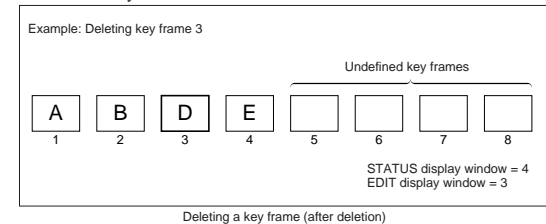

Repeat steps 5 and 6 as required to delete more key frames.

(continued)

User Program Effects

- When you have deleted all the desired key frames, press the EDIT button.

The button goes off, and the user program effect is resaved without the deleted key frames.

Temporarily saving key frame data (temporary assignment function)

While editing user program effects, you can temporarily assign key frame data to keypad numeric buttons. This makes it easy to recall the data for use in changing or adding key frames. You can save 10 sets of data each for linear and nonlinear effects, for a total of 20 key frames.

To save key frame data

Use the following procedure.

- Press the EDIT button to switch to user program edit mode.
- Adjust the parameters in the menu, to create the key frame.
- Display page 3/3 of the menu.
- Hold down the F1(CpTo+) button, and press a numeric button in the pattern/numeric keypad.

The indication for the selected number in the menu changes from “-” to “*”, and this saves the key frame temporarily.

To recall a key frame

Use the following procedure.

- Press the EDIT button to switch to user program edit mode.
- Display page 3/3 of the menu.
- Hold down the F2(CpFrm+) button, and press a numeric button in the pattern/numeric keypad.

This recalls the temporarily saved key frame.

Notes

- You cannot use a linear key frame in a nonlinear effect, nor a nonlinear key frame in a linear effect.
- The key frames temporarily saved in numeric buttons are lost when the DFS-700/700P is powered off.

Copying a key frame

You can use the temporary assignment function to copy data from one key frame to another.

Use the following procedure.

- Recall the user program effect you want to copy from, and press the EDIT button, turning it on.

For details see “To recall a user program effect” (page 4-12).

- Press the UP or DOWN button in the pattern/numeric keypad until the number of the key frame you want to copy from appears in the EDIT display window.
- Display page 3/3 of the menu.
- Hold down the F1(CpTo+) button, and press a numeric button in the pattern/numeric keypad.

The indication for the selected number in the menu changes from “-” to “*”, and this saves the key frame temporarily.

- Press the EDIT button, turning it off, and exit user program edit mode.
- Recall the user program effect to which you want to copy, and press the EDIT button, turning it on.

Note

The copy destination must be a user program effect of the same type (linear or nonlinear) as the copy source.

- Press the UP or DOWN button in the pattern/numeric keypad, until the number of the key frame you want to copy to appears in the EDIT display window.
- In page 3/3 of the menu, hold down the F2(CpFrm+) button, and press the numeric button in which you saved the key frame in step 4.
- Press the ENTER button.

This copies the key frame data to the destination.

- When the copy is completed, press the EDIT button, turning it off.

User Program Effects

Executing User Program Effects

You execute a user program effect in the same way as a built-in effect, by entering the pattern number.

Transitions between the key frames in user program effect are smooth because spline interpolation is used to generate intermediate effects. You can control the smoothness of transitions by adjusting the spline curve. To execute a user program effect, use the following procedure. Except for step 4, the procedure is the same as for executing a built-in effect by specifying the pattern number.

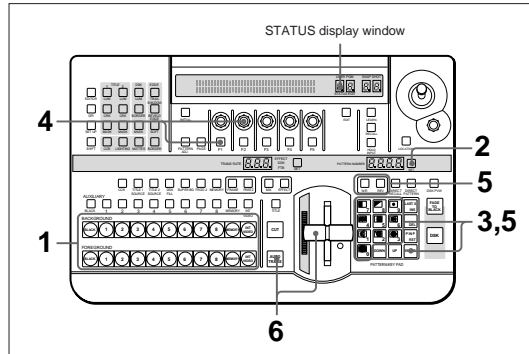

- 1 Select the background and foreground images.
- 2 Press the SET button.
- 3 In the pattern/numeric keypad, enter the user program effect number with buttons 0 to 9 and press ENTER.

The STATUS display window shows the number of key frames in the effect.

- 4 If necessary, use F1 button and F2 knob to adjust the smoothness of the transition.
- 5 Set the duration and direction of the transition as required.
- 6 Execute the effect with the fader lever or AUTO TRANS button.

Deleting All User Program Effects

To delete all user program effects, use the following procedure.

- 1 Press the SET UP button.
The setup menu appears.
- 2 Press the PAGE button, to display page 6/8.
- 3 Press the F4(USRPGM) button, to set it to "ON".
- 4 Press the F5(EXEC) button.

A confirmation message appears.

- 5 To go ahead and delete all user program effects, press F3(OK); to cancel press F5(CANCEL).

When you press F3, all of the saved user program effects are deleted.



Snapshots

This unit's snapshot function allows you to save the control panel state, and recall it whenever necessary.

You can save up to one hundred control panel states in snapshot registers in the processor numbered from 0 to 99.

When you recall a saved snapshot, the control panel settings all change automatically.

The following are the settings which you can save in a snapshot.

Operational section	Settings
Primary cross-point bus section	Signal selected by the FOREGROUND bus buttons
	Signal selected by the BACKGROUND bus buttons
	Signal selected by the TITLE1 SOURCE bus button
	Signal selected by the TITLE2 SOURCE bus button
	Signal selected by the DSK FILL bus button
	Signal selected by the SUPER BG bus button
	Signal selected by the FRGD 2 bus button
	Signal selected by the MEMORY bus button
Effect transition section	Transition time
	Transition direction (REVERSE button setting)
	FRAME button setting
Pattern/numeric keypad	Specified pattern number
LIGHTING section	All settings
TITLE section	All settings
MATTES section	Color matte colors
DSK section	All settings
Effect control section	User modifiable effect parameter settings
EDGE section	All settings
Location section	All settings

Note

The color corrector settings and fader lever position are not saved in a snapshot.

Saving a Snapshot

To save a snapshot, use the following procedure.

Note

The unit is shipped with snapshots saved in registers 0 to 99. By carrying out the following procedure you overwrite these settings.

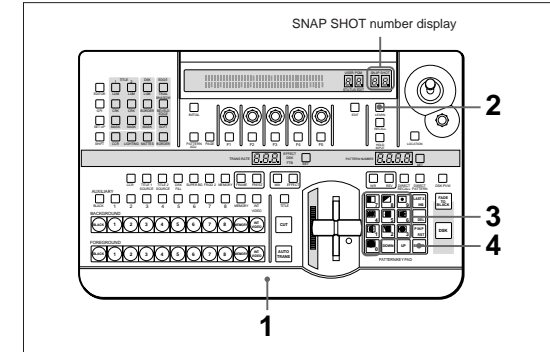

- 1 Set the buttons and controls on the control panel so that it is configured to the state you want to save.
- 2 Press the LEARN button.

The button lights, and the pattern/numeric keypad is ready to accept a snapshot number.
- 3 With the buttons 0 to 9, enter the snapshot number you want to save (0 to 99).
You can use the UP and DOWN buttons to adjust the number displayed.
- 4 Press the ENTER button.

This saves the current settings in the snapshot register.

To cancel the snapshot saving operation

In step 4, press the LEARN button instead of the ENTER button. The LEARN button goes out and the operation is canceled.

Snapshots

Recalling a Snapshot

To recall a snapshot, use the following procedure.

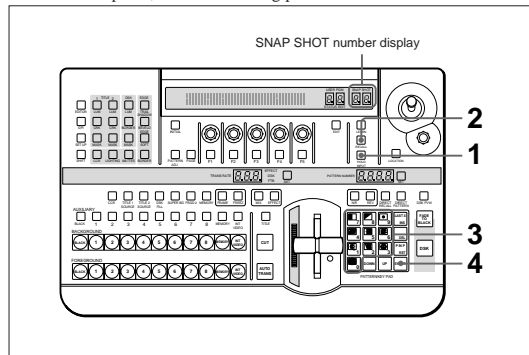

- 1** To leave the primary cross-point bus section settings unaltered, press the HOLD INPUT button, turning it on.
The button lights, and the pattern/numeric keypad is ready to accept a snapshot number.
- 2** Press the RECALL button.
The button lights, and the pattern/numeric keypad is ready to accept a snapshot number.
- 3** With the buttons 0 to 9, enter the snapshot number you want to recall. You can use the UP and DOWN buttons to adjust the number displayed.
- 4** Press the ENTER button.
This recalls the specified snapshot, and the control panel settings all change correspondingly.
If, however, you turned the HOLD INPUT button on in step 1, the settings of the primary cross-point bus section do not change.

Direct Snapshot Recall

You can recall snapshots 0 to 9 with a single button operation.

Use the following procedure.

- 1** In the pattern/numeric keypad, press the DIRECT RECALL button, turning it on.
This switches to direct recall mode.
- 2** Press the one of buttons 0 to 9 corresponding to the snapshot you want to recall.
This recalls the snapshot.

To cancel the snapshot recall operation

In step 4, press the LEARN button instead of the ENTER button. The LEARN button goes out and the operation is canceled.

Returning to the previous image with the LAST X function

To return to the state before recalling a snapshot, use the following procedure.

- 1** Press the RECALL button in the snapshot section, turning it on. Alternatively, press the DIRECT RECALL button, turning it on.
- 2** Hold down the ENTER button in the pattern/numeric keypad, and press the LAST X button.

Snapshot Demonstration

You can automatically show all of snapshots 0 to 99 in sequence. You can use this function for checking the snapshots, and also in the same manner as the factory setting demonstration (*see page 3-8*). The snapshot registers and factory setting demonstration registers are separate. Even after changing the settings in the snapshot registers, you can still run the factory setting demonstration unchanged.

To start the demonstration

Hold down buttons 1 and 9 in the pattern/numeric keypad, and press the AUTO TRANS button in the effect transition section. This plays back the snapshots in sequence, starting from the snapshot whose number is specified at the time. During the demonstration, the buttons on the pattern/numeric keypad light in turn in the clockwise direction.

- The HOLD INPUT button setting also applies to the demonstration.
- During the demonstration, the control panel does not accept any operations other than pressing the AUTO TRANS button.

To end the demonstration

Press the AUTO TRANS button once more.

Snapshots

Reinitializing the Snapshots

By reinitializing the snapshot registers, you can return them all to their factory defaults.

Use the following procedure.

- 1 Press the SET UP button.

The setup menu appears.

- 2 Press the PAGE button to display page 6/8.

- 3 Press the F2(SNAP) button, to set it to "ON".

- 4 Press the F5(EXEC) button.

A confirmation message appears.

- 5 To go ahead and reinitialize all snapshots, press F3(OK); to cancel press F5(CANCEL).

When you press F3, all of the snapshots are returned to their factory defaults.

Chapter 5

Control From Editing Control Units

Control From the PVE-500

You can combine the DFS-700/700P with the PVE-500 Editing Control Unit to carry out A/B roll editing using two players and one recorder. The PVE-500 controls the DFS-700/700P using PVE-500 control signals and GPI signals.

Note

For details of pre-read editing, see the section "Pre-read Editing" (*page 5-14*).

Control using PVE-500 control signals

You can control the following DFS-700/700P functions using 9-pin serial control signals from the PVE-500. Input these signals to the EDITOR connector on the rear panel of the DFS-700/700P.

- Selecting the background image (FROM source) and foreground image (TO source)
- Setting the transition duration
- Executing auto transitions
- Automatic snapshot (when you save editing data on the PVE-500, DFS-700/700P snapshots are saved and recalled automatically.)

For more information about controlling these functions, refer to the PVE-500 Operating Instructions.

Downstream key control using GPI signals

You can use GPI pulse signals from the PVE-500 to turn the DFS-700/700P downstream key function on or off on the falling edge of a pulse. Input the GPI signals to the T2 connector on the DFS-700/700P.

For details of GPI signal timing, see page 5-13.



Control From the PVE-500

Preparations

Make the following preparations to control the DFS-700/700P from the PVE-500.

On the DFS-700/700P

- In page 1 of the setup menu, set F3(PORTS) to “PVE-500”.
- To accept 9-pin serial control signals, press the EDITOR button on the control panel, turning it on. To accept GPI signals, press the GPI button, turning it on.
(When the DFS-700/700P is powered on, it accepts either 9-pin serial control signals or GPI signals.)

On the recorder VCR

- Set the recorder VCR so that it enters PB (playback) mode when stopped. (If the VCR has a selector for PB or PB/EE, set it to PB.)
- If the VCR has a built-in TBC, set the VCR to DELAYED SYNC mode.

On the PVE-500

Using the setup menu, make the following settings.

For more information about using the setup menu, refer to the PVE-500 Operating Instructions.

- Set the switcher type (menu item SEtUP-20) to 500. (The factory default setting is 500.)
- If you want to use the automatic snapshot function, set snapshot control (menu item SEtUP-21) to On. (The factory default setting is OFF.)

Cut Editing

To perform a cut edit by controlling the DFS-700/700P from the PVE-500, use the following procedure.

For this operation, refer also to the PVE-500 Operating Instructions.

- 1 Press the A/B button on the PVE-500 turning it off.
- 2 Select the player VCR as the FROM source.
- 3 Set the IN and OUT points for the FROM source and recorder, in any order.
- 4 Conduct a preview as required, and execute the edit.

A/B Roll Editing

Signal flow

The flow of signals in A/B roll editing is shown below.

For more information about connections, see “Connections for an A/B Roll Editing System” (page 6-5).

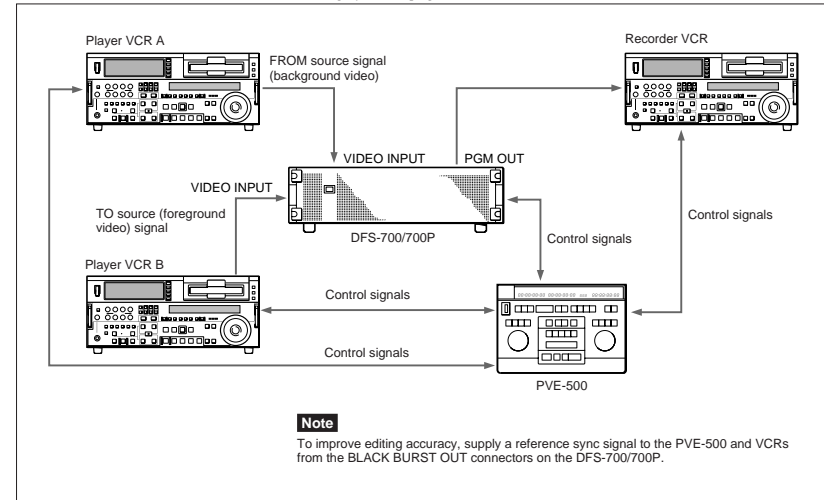

Signal flow in A/B roll editing

Control From the PVE-500

Procedure

To perform A/B roll editing by controlling the DFS-700/700P from the PVE-500, use the following procedure.
Read this in conjunction with the PVE-500 Operating Instructions.

- 1 On the PVE-500, press the A/B button, turning it on.
- 2 On the PVE-500, select the FROM source and TO source. The FROM source corresponds to the background on the DFS-700/700P, and the TO source corresponds to the foreground.
- 3 Set the IN and OUT points for the FROM source, the TO source, and the recorder, in any order.

Note

Because the DFS-700/700P has a built-in frame synchronizer, output of player VCR edit points set on the PVE-500 is delayed by 1 frame, so that recording begins with the previous frame. However, recorder edit points are not delayed.

- 4 On the PVE-500, press the TRANS button, turning it on, and set the transition duration.
- 5 On the DFS-700/700P, select the effect and make other settings as required. Note that the transition duration set on the PVE-500 takes priority.
- 6 Conduct a preview as required and execute the edit.

The edit is recorded as shown below.

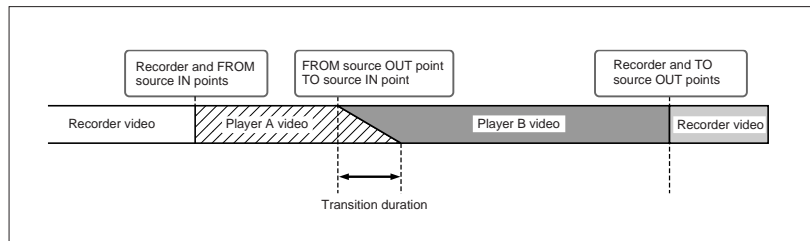

Control From the BVE-600

You can combine the DFS-700/700P with a BVE-600 Editing Control Unit to carry out A/B roll editing using two players and one recorder. The BVE-600 controls the DFS-700/700P using the GPI trigger signals T1 and T2.

Notes

- You cannot use the built-in switcher of the BVE-600 (BKE-611/612/621/622) when you are using the DFS-700/700P.
- For details of pre-read editing, see the section “Pre-read Editing” (page 5-14).

Preparations

Make the following preparations to control the DFS-700/700P from the BVE-600.

For details of operation, refer to the BVE-600 Operating Instructions.

On the DFS-700/700P

- In page 1 of the setup menu, set F3(PORTS) to “BVE-600”.
- Press the EDITOR button on the control panel, turning it on. (This button is lit when the DFS-700/700P is powered on.)

On the recorder VCR

- Set the recorder VCR so that it enters PB (playback) mode when stopped. (If the VCR has a selector for PB or PB/EE, set it to PB.)
- If the VCR has a built-in TBC, set the VCR to DELAYED SYNC mode.

On the BVE-600

On the rear panel, set S502 DIP switch 3 and S503 DIP switch 2 to the lower position (OFF), and power the BVE-600 on again.

When the unit is shipped from the factory, all DIP switches are set to the upper position (ON).

Notes

- To display the background image during or after a transition, press an appropriate BACKGROUND bus button on the DFS-700/700P.
- Because the DFS-700/700P has a built-in frame synchronizer, output of player VCR edit points set on the BVE-600 is delayed by 1 frame, so that recording begins with the previous frame. However, recorder edit points are not delayed. For example, if the IN point of the player VCR is set to 00:00:10:15, actual recording begins from 00:00:10:14.
- The timing of the start of a transition is delayed by two frames from the BVE-600 setting.

Control From the BVE-600

A/B Roll Editing

Signal flow

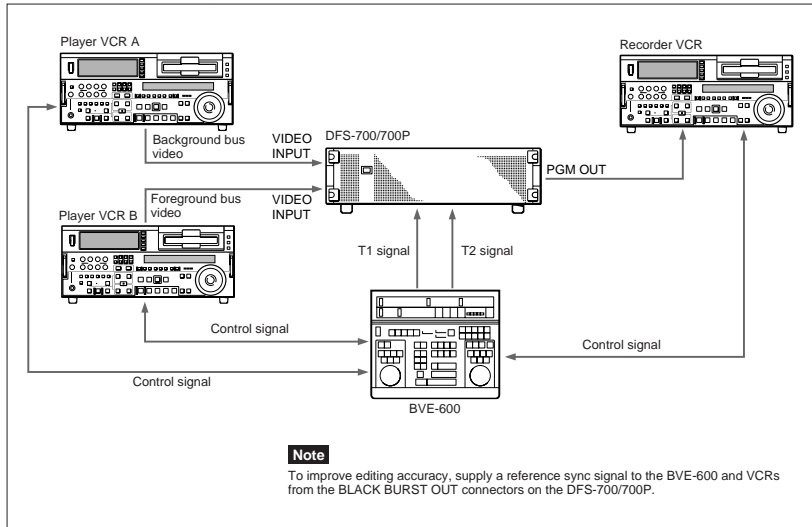

Signal flow in A/B roll editing

Timing of the trigger (T1/T2) signals

The timing of the trigger signals output by the BVE-600 is as follows.

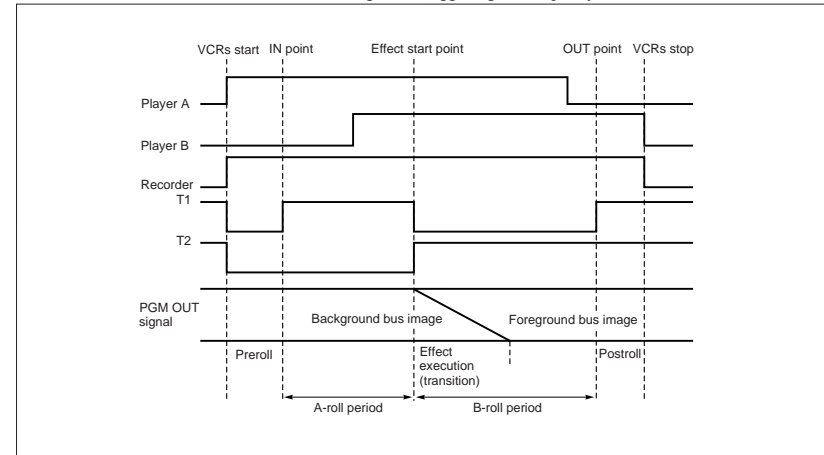

Timing of trigger signals in A/B roll editing

Control From the BVE-900/2000 Series

You can combine the DFS-700/700P with a BVE-900/910 or BVE-2000 Series Editing Control Unit to carry out A/B roll editing using two players and one recorder.

For details of pre-read editing, see the section "Pre-read Editing" (page 5-14).

Connectable editing control units

To control the DFS-700/700P, the BVE-900/910/2000 and optional BKE-913 board (for BVE-900/910) must have the following ROM versions or higher.

BVE-900	Ver. 1.11 or later
BVE-900 with BKE-900K	Ver. 2.01 or later
BVE-910	Ver. 1.02 or later
BKE-913	Ver. 1.06 or later
BVE-2000	Ver. 1.10 or later

Control using editor control signals

You can control the following DFS-700/700P functions using 9-pin serial control signals from the BVE-900/910/2000. Input these signals to the EDITOR connector on the rear panel of the DFS-700/700P. The functions marked with an asterisk below can only be controlled from the BKE-900 after installation of the optional BKE-900K board.)

- Background image (FROM source) and foreground image (TO source) selection
- Pattern number selection
- Transition direction (normal or reverse) selection
- Transition duration selection
- Automatic transition execution
- Downstream key on and off
- Snapshot saving and recall*
- Saving and loading DFS-700/700P data (snapshots and user program effects)*

Notes

- It is not possible to load and save user program effects or snapshots from the BVE-900/910.
- KEY FADE IN and KEY FADE OUT cannot be used. Also, KEY WIPE OUT and KEY MIX OUT can only be used with versions 2.24 and later of the BVE-2000.

When using KEY WIPE OUT, the effect must be executed in the reverse direction.

Downstream key control using GPI signals

You can use signals from the GPI output connector on the BVE-900/910/2000 to turn the DFS-700/700P downstream key function on and off. Input the GPI signals to the T2 connector on the rear panel of the DFS-700/700P. (The BVE-2000 can also use 9-pin serial control signals to turn the downstream key on and off and to set the transition duration.)

Preparations

Make the following preparations to control the DFS-700/700P from the BVE-900/2000-series editor.

For details about operation, refer to the Operating Instructions or User's Guide supplied with the editor.

On the DFS-700/700P

- In page 1 of the setup menu, set F3(PORTS) to "PVE-500".
- To accept 9-pin serial control signals, press the EDITOR button on the control panel, turning it on. To accept GPI signals, press the GPI button, turning it on.
(When the DFS-700/700P is powered on, it accepts either 9-pin serial control signals or GPI signals.)
- To improve editing accuracy, supply a reference sync signal to the VCRs and editing control unit from the BLACK BURST OUT connectors on the DFS-700/700P.

On the recorder VCR

Set the recorder VCR so that it enters PB (playback) mode when stopped. (If the VCR has a selector for PB or PB/EE, set it to PB.)

On the BKE-900/910

Set the PVW (preview) mode to EE.

- **BVE-900 with no BKE-900K installed:** In SYSTEM SETUP mode, set BYTE-1 of the MAIN BLOCK INTERFACE parameters to hexadecimal "01" (EE).
- **BVE-910, or BVE-900 with BKE-900K installed:** In SYSTEM SETUP mode, set PVW MODE under SW'ER CONFIGURATION to EE.

On the BVE-2000

- In SYSTEM SETUP mode, set PVW MODE under SW'ER CONFIGURATION to EE.
- In SYSTEM SETUP mode, set SW'ER TYPE under SW'ER CONFIGURATION to DFS.
However, for versions 2.24 and later of the BVE-2000, select DFS-700/700P.

Control From the BVE-900/2000 Series

Notes on Operation

Editing point delay

Because the DFS-700/700P has a built-in frame synchronizer, output of player VCR edit points set on the BVE-900/910/2000 is delayed by 1 frame, so that recording begins with the previous frame. However, recorder edit points are not delayed.

Example: If the IN point of the player VCR is set to 00:00:10:15, recording begins from 00:00:10:14.

If you are using a BVE-2000 with a ROM version of 2.00 or higher, in SYSTEM SETUP mode under SYSTEM CONFIGURATION you can set the DIGITAL EFFECT DELAY item to 01 so that the BVE-2000 compensates for the delay automatically.

Executing effects in the reverse direction

- To execute an effect in the reverse direction from the BVE-900/910, add 3000 to the DFS-700/700P effect pattern number. However, add 500 to the pattern numbers of user program effects (pattern numbers 9000 and above).

Examples:

To execute effect 25 in the reverse direction, specify pattern number 3025.

To execute effect 9203 in the reverse direction, specify pattern number 9703.

- To execute an effect in the reverse direction from the BVE-2000, add a minus sign (-) before the DFS-700/700P pattern number.

Example:

To execute effect 25 in the reverse direction, specify effect pattern number -25.

Effect intervals

Effects cannot be executed if there is no interval between transitions, as shown below in figure (a).

Be sure to leave an interval of at least two frames or more between transitions, as shown in figure (b).

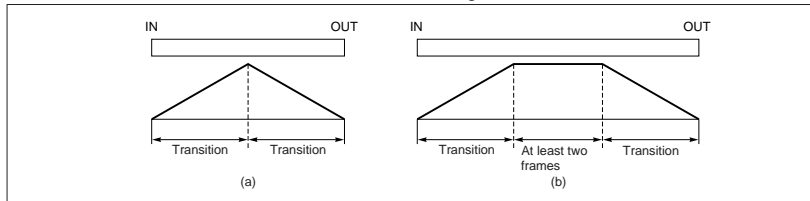

Minimum interval between transitions

Control Using GPI Signals

You can combine the DFS-700/700P with any editing control unit capable of GPI signal output to carry out A/B roll editing using two players and one recorder.

You can use one GPI signal to execute DFS-700/700P effects, and a second GPI signal to turn the downstream key function on and off.

Preparations

Make the following preparations to control the DFS-700/700P using GPI signals output by the editing control unit.

For details about operation, refer to the manuals supplied with your editing control unit.

On the DFS-700/700P

- In page 1 of the setup menu, set F3(PORTS) to "GPI".
- Press the EDITOR button on the control panel, turning it on. (This button is lit when the DFS-700/700P is powered on.)

On the recorder VCR

- Set the recorder VCR so that it enters PB (playback) mode when stopped. (If the VCR has a selector for PB or PB/EE, set it to PB.)
- If the VCR has a built-in TBC, set the VCR to DELAYED SYNC mode.

On the editing control unit

- Set the GPI signal output timing to 3 frames before the IN point.
- Set the GPI signal pulse length to at least 1 frame.

Notes

- To display the background image during or after a transition, press an appropriate BACKGROUND bus button on the DFS-700/700P.
- Because the DFS-700/700P has a built-in frame synchronizer, output of player VCR edit points set on the editing control unit is delayed by 1 frame, so that recording begins with the previous frame. However, recorder edit points are not delayed. For example, if the IN point of the player VCR is set to 00:00:10:15, recording begins from 00:00:10:14.

Control Using GPI Signals

A/B Roll Editing

Signal flow

The flow of signals in A/B roll editing is as follows.

For more information about connections, "see Connections for an A/B Roll Editing System" (page 6-5).

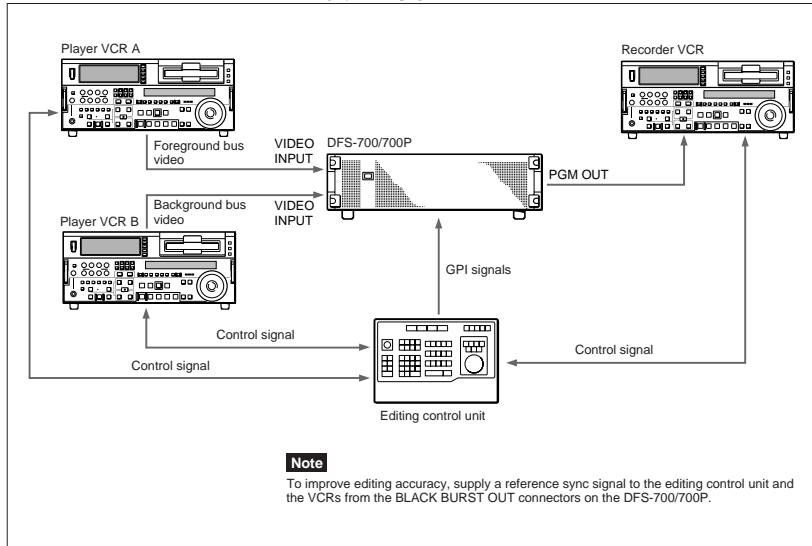

Note
To improve editing accuracy, supply a reference sync signal to the editing control unit and the VCRs from the BLACK BURST OUT connectors on the DFS-700/700P.

Signal flow in A/B roll editing

Timing of the GPI signal

The timing of the GPI signal from the editing control unit is as follows.

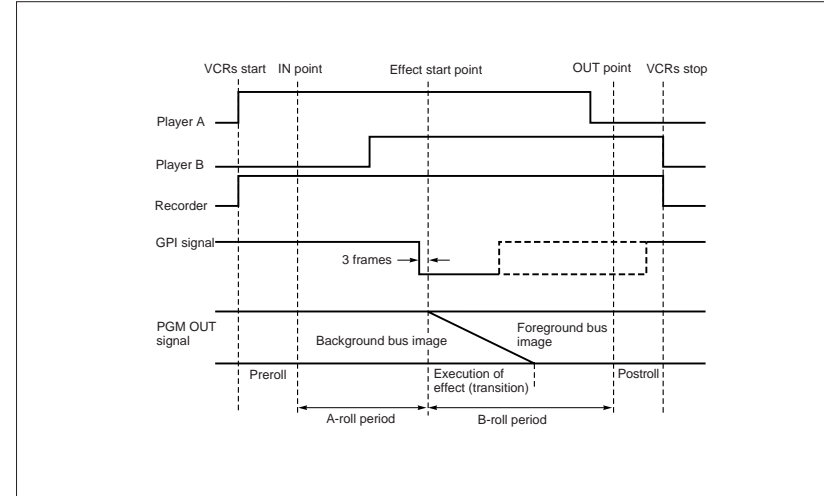

Timing of GPI signal in A/B roll editing

Turning a Downstream Key On and Off

If in page 1 of the setup menu you have set F3(PORTS) to "PVE-500" or "GPI" then you can turn a downstream key on and off using a GPI signal input to the T2 connector on the DFS-700/700P. As shown below, the downstream key is turned alternately on and off at the falling edge of the GPI signal.

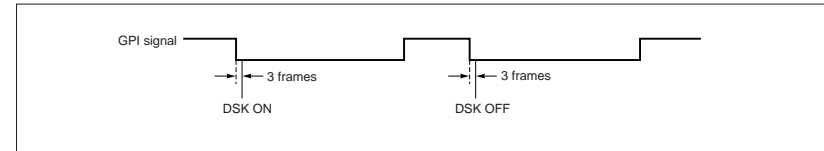

Turning a downstream key on and off — GPI signal timing

Preread Editing

Notes on preread editing

- A BVE-2000 Ver. 2.24 or later is recommended as the editor.
In this case, set PREVIEW MODE to FULL, and use a monitor connected to the DFS-700 PROGRAM OUT.
If using a BVE-2000 earlier than Ver. 2.24 or another editor, previewing is not possible.
- It is not possible to set the DFS-700 preread mode from the editor.
It must be set manually.
For an editor other than the BVE-2000, it is not possible to set the preread mode for the VTR. It must be set manually.
- During preread editing, the effect patterns which can be used are restricted to those for which a title can be used automatically.
- During normal editing the video output is delayed by one frame, but during preread editing, the video selected on the background bus only is delayed by 4H.
When carrying out R to P or P to R editing make sure that the background bus signal is available to the R.
- To obtain the DFS-700/700P program output, use digital PGM OUT or analog component PGM OUT connectors on the DFS-700/700P processor unit.

Settings for preread editing

Preparations on the DFS-700/700P

In page 1 of the setup menu, set F2(PRE_RD) to ON. When PRE_RD is set to ON, a "P" appears at the beginning of line 2 of the menu display, indicating preread mode. (Except during preread editing, if PRE_RD is set to ON the edit points will be shifted, so be sure to set it to OFF. It is not possible to make this setting from the editor.)

Preparations on a BVE-2000 earlier than Ver. 2.24

Set AUX F7(PREREAD) to ON.

Preparations on a BVE-2000 Ver. 2.24 or later

- In SYSTEM SETUP mode set the PREVIEW MODE of SW'ER CONFIGURATION to FULL.
- Set AUX F7(PREREAD) to ON.
- In SYSTEM SETUP mode set the DIGITAL EFFECT DELAY of SYSTEM CONFIGURATION to 01.

Chapter 6

System Connections and Settings

This section describes how to connect the DFS-700/700P to other equipment. It also lists the setup operations required before you can use the DFS-700/700P.

Note

Before making connections, ensure that all of the devices are powered off.

Basic System Connections

The following are the connections required for basic image creation with the DFS-700/700P.

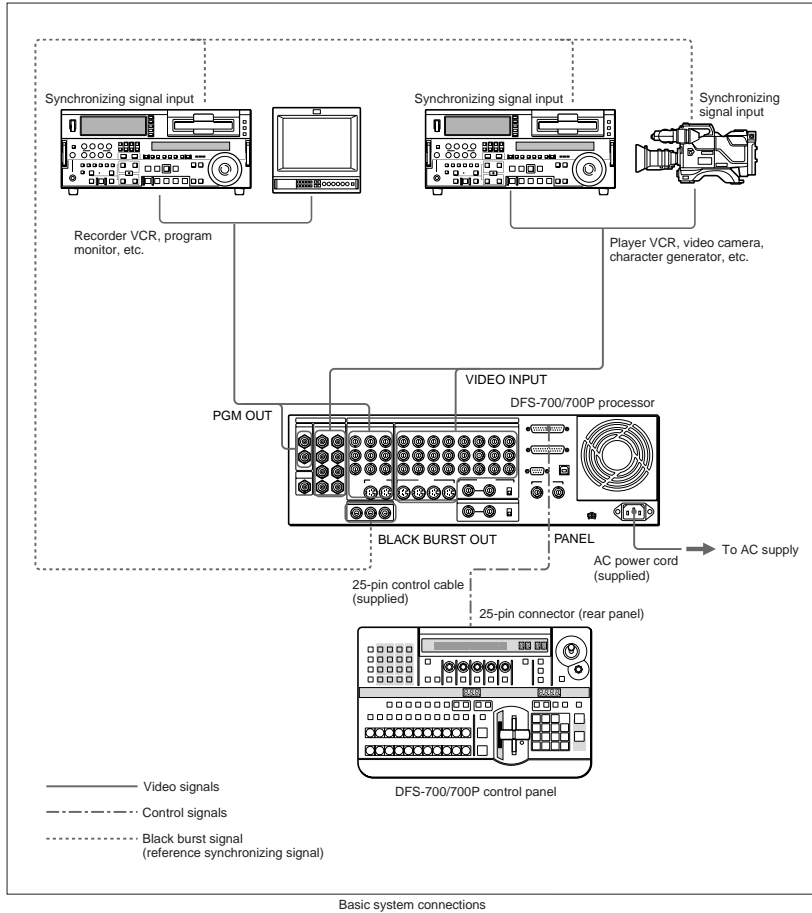

Key Signal Connections

These connections are for the signals for title keys and downstream keys (DSK) for inserting text and graphics.

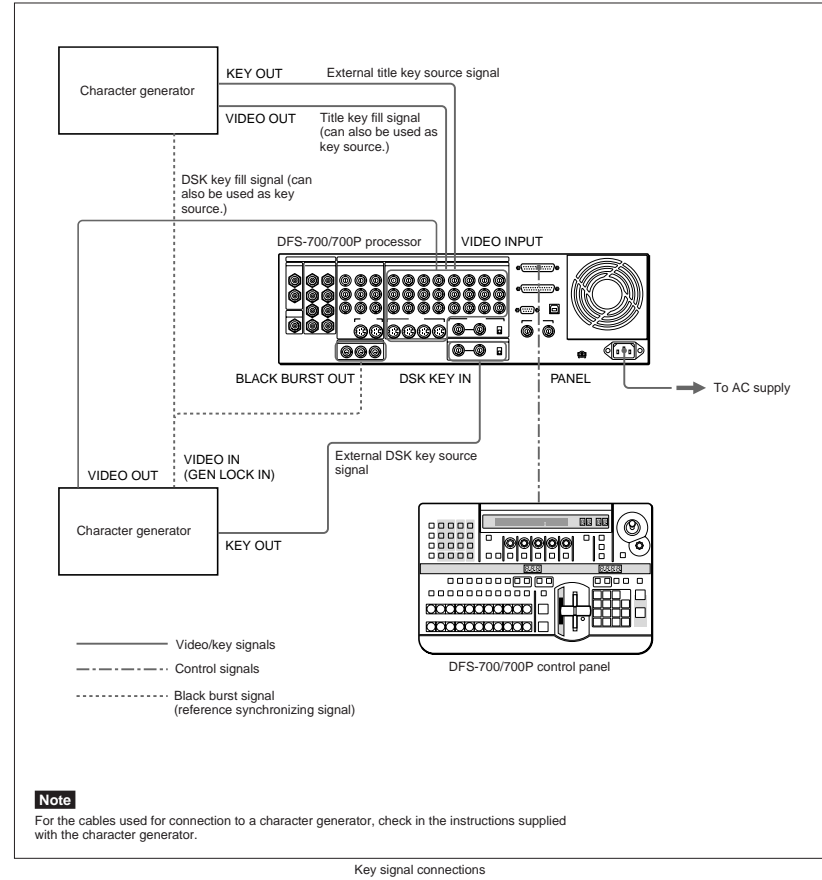

System Connections for Preread Editing

By combining a BVE-2000 editing control unit and a VCR capable of preread editing (such as the DSR-2000), you can build a preread editing system.

Note

The video from the player VCR is delayed by one frame in the DFS-700/700P, and therefore playback advanced by one frame is required.

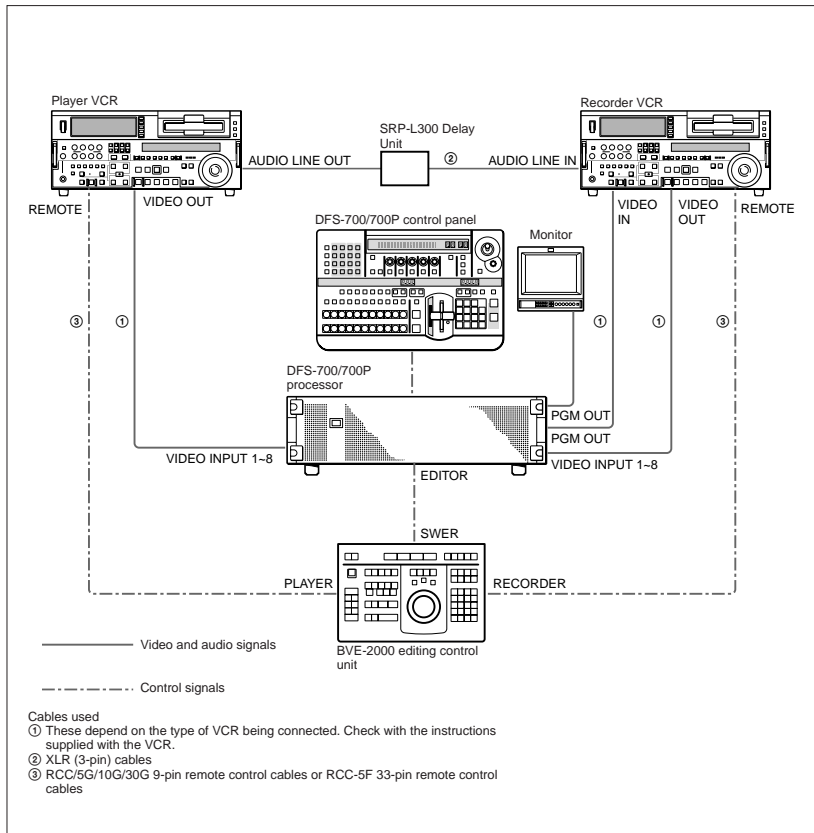

Preread editing system connections

- Cables used
 ① These depend on the type of VCR being connected. Check with the instructions supplied with the VCR.
 ② XLR (3-pin) cables
 ③ RCC/5G/10G/30G 9-pin remote control cables or RCC-5F 33-pin remote control cables

Connections for an A/B Roll Editing System

By combining a BVE-2000 or PVE-500 editing control unit with the DFS-700 and two players and one recorder VCR, you can build an A/B roll editing system. Using an editor with GPI signal support, A/B roll editing controlled by GPI signals is also possible.

When using GPI signals

Control the M/E through the GPI/T1 connector, and the downstream keyer through the GPI/T2 connector. You can control M/E and downstream keys simultaneously.

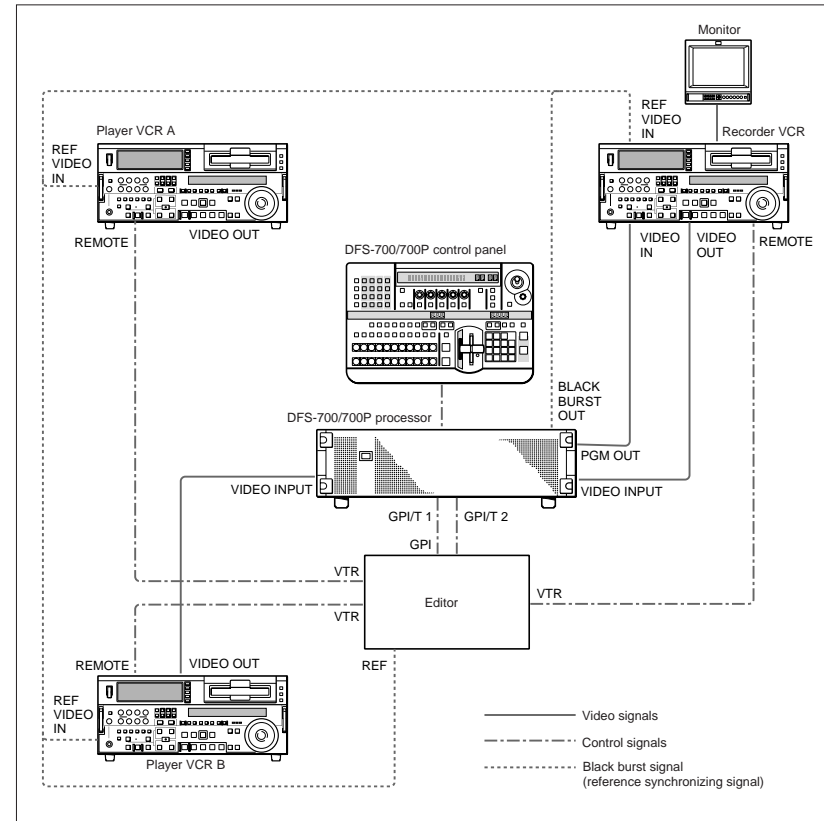

A/B roll editing system connections (1) — using GPI signals

- Video signals
 - - - Control signals
 ····· Black burst signal (reference synchronizing signal)

Connections for an A/B Roll Editing System

When using the BVE-2000

Control the M/E and downstream keyer through the 9-pin connector. You can control M/E and downstream keys simultaneously.

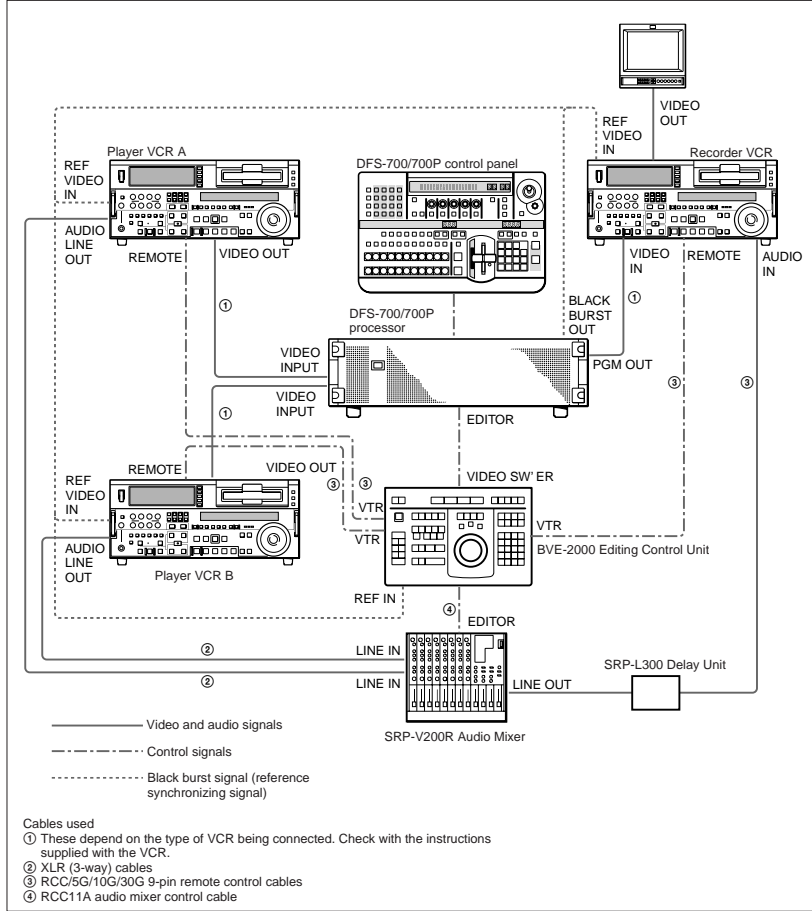

A/B roll editing system connections (2) — using the BVE-2000

Setup Menu Settings

Setup Menu Organization

The setup menu is divided into eight pages, and each appears as shown in the following example. Example display:

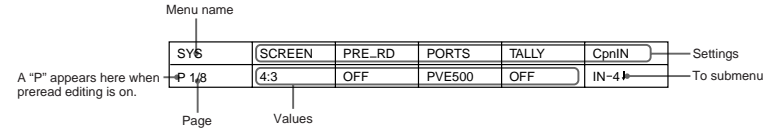

System Setup (page 1/8)

Button	Setting	Meaning	Values (First value is factory default.)
F1	SCREEN	Set screen aspect ratio.	4:3/16:9
F2	PRE RD	Toggle pre-read editing on/off. When this is on, a "P" appears at the beginning of line two of the menu display.	OFF/ON
F3	PORTS	Select type of editor connected to EDITOR connector. (See table below.)	PVE-500/BVE-600/GPI (Select "PVE500" when a BVE-2000 is connected.)
F4	TALLY	Toggle rear panel tally output signal on/off.	OFF/ON
F5	CpnIN (Only appears when optional BKDF-702/702P is installed.)	Assignment of numbers to rear panel COMPONENT connectors 1/4 to 5/8.	IN1-4 ↓: assign 1 to 4. IN5-8 ↓: assign 5 to 8. 1-4/5-8 To confirm displayed assignment, press F3(OK); to cancel press F5(CANCEL).

F3(PORTS) setting and control

Values	Valid control for each connector		
	EDITOR connector	GPI/T 1	GPI/T 2
PVE-500	DVS control	—	DSK transitions
BVE-600	—	Auto transitions	—
GPI	—	Auto transitions	DSK transitions

Setup Menu Settings

System Information Display (page 2/8)

Button	Setting	Meaning	Values
F1	INFO	Display options installed.	CONFIG ↓ BKDF-701/711/712 (Appears as "****" when not installed.) To return, press F5(EXIT ↓).
F2	INFO	Display software version.	VER ↓ DFS-700/700P :x.xx BKDF-712: x.xx DATA: x.xx Panel: x.xx (Appears as "----" when not installed.) To return, press F5(EXIT ↓).
F3	PW ON	Select setup mode at power on.	FACTRY (factory default)/USER (user settings)
F5	INSTL	Install new software.	↓ Press F3(OK) to confirm install; press F5(CANCEL) to cancel.

Input Video Setup (page 3/8)

Button	Setting	Meaning	Values (First value is factory default.)
F1	In No.	Select input to set.	1/2/3/4/5/6/7/8/DSK
F2	TYPE	Select input signal format.	SDI/YUV/Cps/YC/RGB/** (Only types which can be set appear. See the table on the next page. When F1(In No.) is set to DSK, appears as "****".)
F3	TBC	TBC Center setting for the input signal The output signal is output in the correct phase if the phase relationship of the center value with respect to the reference synchronizing signal is in the range $\pm 0.3H$.	0H/0.5H/1H/** This setting is not possible when TYPE is Cps or YC.
F4	+H-pos	Video phase adjustment of input signal	• When SDI, YUV, Cps, YC, or RGB is selected, this can be adjusted from -24 to +24 in steps of 2. • When DSK is selected, this can be adjusted from -30 to +31 in steps of 1.
F5	+XPT	Cross-point button assignment to input signals	1/2/3/4/5/6/7/8/** (When F1(In No.) is set to DSK, appears as "****".) To assign a signal, hold down the function key, and press a cross-point button on the background bus.

Primary inputs and signal formats

SDI: serial digital signals

Component: analog component signals

Composite: analog composite signals

YC: analog YC signals

RGB: analog RGB signals (G signal with sync)

Input number	1	2	3	4	5	6	7	8
With standard equipment	SDI	SDI	SDI	SDI	Component	Component	Component	Component RGB
With BKDF-701 installed	SDI Component	SDI Component	SDI Component	SDI Component RGB	SDI Component	SDI Component	SDI Component	SDI Component
With BKDF-702/702P installed (mode 1) ^{a)}	SDI Component	SDI Component	SDI Component	SDI Component RGB	Composite YC	Composite YC	Composite YC	Composite YC
With BKDF-702/702P installed (mode 2) ^{b)}	SDI	SDI	SDI	SDI	Component Composite YC	Component Composite YC	Component Composite YC	Component RGB Composite YC

a) Setup menu item CpnIN set to "IN 1-4"

b) Setup menu item CpnIN set to "IN 5-8"

Output Video Setup (page 4/8)

Button	Setting	Meaning	Values (First value is factory default.)
F1	CLEAN	Select output video from CLEAN OUT connector.	CLEAN/KEYOUT/PVV (See page 2-15.)
F2	CLIP	Toggle white clip and dark clip on/off. Only valid for SDI output signals, and the SDI standard white and dark values are applied.	OFF/ON
F3	T-Area	Toggle safe title indication on preview video using CLEAN OUT connector on/off. When on, the safe title indication shows approximately 85% of the whole image area. This item appears when F1(CLEAN) is set to "PVV".	OFF/ON
F4	FLD FZ	Select the field output when the internal frame memory is set to field freeze mode.	ODD/EVEN

Setup Menu Settings

Control Panel Setup (page 5/8)

Button	Setting	Meaning	Values (First value is factory default.)
F1	BEEPER	Toggle beeper on/off.	ON/OFF ON: Beeper sounds if the fan stops, there is a power supply error, an operation error or a key pad operation. OFF: Beeper only sounds if the fan stops or there is a power supply error.
F2	BRIGHT	Brightness of control panel fluorescent indicators	LOW/HIGH
F3	SAVER	Toggle screen saver on/off. When on, the screen saver operates when there is no button operation for ten minutes.	OFF/ON
F4	FTB	Enable/disable FADE TO BLACK function. Setting DISABL makes the function not available.	ENABLE/DISABL

Initializing User Settings (page 6/8)

Button	Setting	Meaning	Values (First value is factory default.)
F1	SETUP	Initialize setup data.	OFF/ON
F2	SNAP	Initialize snapshot.	To initialize an item, set it to "ON". It is not possible to initialize more than one item at a time.
F3	USRPGM	Initialize user program effects.	
F4	KEYPAD	Initialize keypad data.	
F5	EXEC	Execute initialization selected from F1 to F4.	To initialize, press F3(OK); to cancel press F5(CANCEL).

Loading User Settings From Memory (page 7/8)

Button	Setting	Meaning	Values (First value is factory default.)
F1	SETUP	Load setup data.	OFF/ON
F2	SNAP	Load snapshot.	OFF/ON
F3	USRPGM	Load user program effects.	OFF/ON
F4	KEYPAD	Load keypad data.	OFF/ON
F5	EXEC	Execute load selected from F1 to F4.	To load, press F3(OK); to cancel press F5(CANCEL).

Saving User Settings in Memory (page 8/8)

Button	Setting	Meaning	Values (First value is factory default.)
F1	SETUP	Save setup data.	OFF/ON
F2	SNAP	Save snapshot.	OFF/ON
F3	USRPGM	Save user program effects.	OFF/ON
F4	KEYPAD	Save keypad data.	OFF/ON
F5	EXEC	Execute save selected from F1 to F4.	To save, press F3(OK); to cancel press F5(CANCEL).

Appendixes

Warning Messages

Warning messages appear in the menu display panel of the control panel when trouble occurs during operation of the DFS-700/700P. Press the F5 (OK) button to erase the message.

Warning message format

Warning messages are displayed in the following format.

Number	Problem	What to do
011	FAN STOP!!->	Turn OFF Power

Warning Messages

Warning message list

The following warning messages are displayed.

Display	Meaning	What to do
011 FAN STOP!! ->Turn OFF Power	The processor detected that the power supply fan is stopped.	Turn off the power and check the power supply fan. If this does not solve the problem, contact a Sony service representative.
012 Power Unit Error ->Turn OFF Power	There is trouble with the power supply.	Turn off the power and check the power supply. If this does not solve the problem, contact a Sony service representative.
021 Reference Signal Error ->	Video sync signals are not being sent correctly from the main unit to the control panel.	Check the cable connection.
022 Self Diagnostic Error xxxx/xxxx -> Check on Maintenance menu	An error was detected during self diagnostics when the system was powered on. (xxxx/xxxx indicates the error status.)	Contact your vendor or a Sony service representative.
023 Software Version Mismatch -> Load the latest S/W	The processor and control panel software versions are different.	Contact your vendor or a Sony service representative.
031 Data Backup Error ->	User program, setup or other data could not be written to backup memory.	Contact your vendor or a Sony service representative.

Effect Type List

The effects provided by the DFS-700/700P are classified as follows.

Pattern No.	Types of effects	The number of available patterns				Reference page no.
		Varieties in standard configuration	Varieties with BKDF-711 installed	Varieties with BKDF-712 installed	Varieties with BKDF-711 and 712 installed	
1-676	Wipe	79	79	79	79	A-29, A-30
700-809	Matrix wipe	37	37	37	37	A-30, A-31
1000-1018	Mosaic	10	10	10	10	A-31
1020-1027	Still mirror	8	8	8	8	A-32
1030-1058	Y&C modify	10	10	10	10	A-32
1059	Cut	1	1	1	1	A-32
1065-1067	Strobe, Cinema	3	3	3	3	A-33
1075-1079	Cropping	5	5	5	5	A-33
1080	Mix	1	1	1	1	—
1100-1128	Picture-in-picture	19	19	19	19	A-33
1130, 1131	Zoom up	2	2	2	2	A-33
1150, 1151	Spotlight	2	2	2	2	A-34
1200-1207	Dynamic mirror	8	8	8	8	A-34
1210-1213	Stream	4	4	4	4	A-34
1230-1233	Accordion	4	4	4	4	A-34
1240, 1241	Multi-screen	2	2	2	2	A-35
1250-1271	Wave modulation	13	13	13	13	A-35
1280-1283	Real paint	4	4	4	4	A-35
1285-1288	Stained glass	4	4	4	4	A-35
1300-1307	Slide	8	8	8	8	A-35
1330-1394	Split slide	32	32	32	32	A-36, A-37
1500-1524	Compress	20	20	20	20	A-38
1530-1535	Expand	6	6	6	6	A-38
1600-1613	2D rotation	12	12	12	12	A-39
1620-1690	2D rotation + Compress + Slide	7	7	7	7	A-39
1700-1707	3D rotation	8	8	8	8	A-40
1730-1742	Door	6	6	6	6	A-40
1750-1753	Split 3D rotation	4	4	4	4	A-40
1760-1824	3D rotation + Compress + Slide	24	24	24	24	A-41
1850-1855	Album turn	6	6	6	6	A-42
1900-1964	Flip, Tumble	33	33	33	33	A-42, A-43
2000-2006	Twist	4	4	4	4	A-43
2100-2144	Page turn	40	40	40	40	A-44
2150-2154	Page turn (modified)	5	5	5	5	A-45
2160-2167	Split page turn	8	8	8	8	A-45
2200-2251	Sphere	11	11	11	11	A-45
2260-2269	Ripple	10	10	10	10	A-46
2270-2279	Burst, Explosion, Ring, Swirl	10	10	10	10	A-46
2280-2284	Amoeba, Melt, Lens	5	5	5	5	A-47

(continued)

Effect Type List

Pattern No.	Types of effects	The number of available patterns				Reference page no.
		Varieties in standard configuration	Varieties with BKDF-711 installed	Varieties with BKDF-712 installed	Varieties with BKDF-711 and 712 installed	
2300-2307	Two-picture slide	0	8	0	8	A-47
2320-2329	Two-picture slide, 2D rotation	0	10	0	10	A-47
2340-2357	Two-picture rotation + Compress + Slide	0	18	0	18	A-48
2360-2375	Two-picture intersect	0	12	0	12	A-49
2380-2395	Two-picture box	0	16	0	16	A-50
2400-2419	Two-picture brick	0	18	0	18	A-51
2420-2437	Two-picture brick (flip type)	0	18	0	18	A-52
2470-2473	Split 3D rotation	0	4	0	4	A-52
2480-2499	Masked flip	0	20	0	20	A-53
2500-2519	2ch picture-in-picture	0	20	0	20	A-54
2520-2534	2ch picture-in-picture	0	13	0	13	A-55
2550-2554	Two-picture page turn	0	5	0	5	A-55
2560-2564	Split page turn	0	5	0	5	A-56
2600-2625	3D split	0	0	10	10	A-56
2630-2633	3D split flip	0	0	4	4	A-57
2640-2651	Multi-cube	0	0	9	9	A-57
2660, 2661	Three-picture multi-cube	0	0	0	2	A-57
2690-2692	Special wipe	0	0	3	3	A-58
2700-2715	3D page turn	0	0	12	12	A-58
2720-2724	3D twist	0	0	5	5	A-58
2730-2739	3D box twist	0	0	10	10	A-59
2740-2752	3D modeling effect	0	0	4	4	A-59
2800-2805	3D beveled edge, Picture-in-picture	0	0	6	6	A-60
2810-2813	3D modeled edge, Picture-in-picture	0	0	4	4	A-60
2820-2827	3D cube, 3D brick	0	0	8	8	A-60
2830-2833	3D cube	0	0	0	4	A-60
2840-2845	3D cylinder, Sphere, Heart	0	0	6	6	A-61
2850-2857	3D wave, 3D flag	0	0	8	8	A-61
2860, 2861	Kaleidoscope	0	0	2	2	A-61
2865, 2866	3D crystal, Mirror cube	0	0	2	2	A-61
2870-2881	3D object effect	0	0	9	9	A-62
9000-9009	Linear user program (transition)	10	10	10	10	4-4
9100-9109	Linear user program (animation)	10	10	10	10	4-4
9200-9209	Nonlinear user program (transition)	10	10	10	10	4-4
9300-9309	Nonlinear user program (animation)	10	10	10	10	4-4

Effect Control Parameter List

You can change effect pattern parameters by using the pattern adjustment knobs, joystick, and Z-knob on the control panel.

F1 to F5: Menu page 1
F6 to F10: Menu page 2
F11 to F15: Menu page 3
X/Y: Joystick
Z: Z-knob

Effect control parameters

Pattern No.	Effect type and adjustable parameters
0017	Wipe
0018	F2: Rotation angle (Angle = 0 to 99) F3: Rotation speed (Rot = 0 to 100) F4: Auto center (CENTER = AUTO/FIX)
0021 to 0029	Wipe
0034 to 0039	F1: Pattern aspect ratio (Aspect = Taller to wider) F2: Rotation angle (Angle = 0 to 99) F3: Rotation speed (Rot = 0 to 100) F4: Auto center (CENTER = AUTO/FIX)
1010 to 1011	User mosaic F1: Size of a mosaic cell (Size = 0 to 100) F2: Aspect ratio of a mosaic cell (Aspect = Wider to taller) F3: Softness (Soft = 0 to 100) F5: Type of cell (TYPE = FLAT, GLASS 1 to GLASS 4)
1015 to 1018	Pattern mosaic F1: Size of a mosaic cell (Size = 0 to 100) F2: Aspect ratio of a mosaic cell (Aspect = Wider to taller) F3: Softness (Soft = 0 to 100) F4: Aspect ratio of the mask area (MskAsp = Wider to taller) F5: Type of cell (TYPE = FLAT, GLASS 1 to GLASS 4)
1040 to 1046	Y&C modify F1: Degree of luminance masking (PstSol = OFF, LEVEL 1 to LEVEL 7)
1050	Y&C modify F1: Degree of luminance masking (Poster = OFF, LEVEL 1 to LEVEL 7) F2: Positive/negative selection (VIDEO = NORMAL/NEGA/MONO/MN+NEG) F3: Softness (Soft = 0 to 100)
1055 to 1058	Y&C modify F1: Degree of luminance masking (Poster = OFF, LEVEL 1 to LEVEL 7) F2: Positive/negative selection (VIDEO = NORMAL/NEGA/MONO/MN+NEG) F3: Softness (Soft = 0 to 100) F4: Aspect ratio of the mask area (MskAsp = Wider to taller)

(continued)

Effect Control Parameter List

Effect control parameters (continued)

Pattern No.	Effect type and adjustable parameters
1065	Strobe F1: Frames displayed per second (Strobe = 0 to 100)
1066 1067	Cinema F1: Frames displayed per second (Strobe = 0 to 100) F2: Wide screen degree (Wide = 0 to 100) F3: Wide screen position (Posi = Bottom to top) F4: Softness (Soft = 0 to 100)
1075 to 1079	Cropping F1: X-coordinate of center (Pos_X = Left to right) F2: Y-coordinate of center (Pos_Y = Bottom to top) F3: Size of pattern (Size = 0 to 100) F4: Aspect ratio of the pattern (Aspect = Taller to wider)
1102 1103 1106 to 1109	Picture-in-picture (three-dimensional) F1: X-axis rotation (Rot_X = -70° to +70°) F2: Y-axis rotation (Rot_Y = -70° to +70°) F3: Z-axis rotation (Rot_Z = -70° to +70°) F4: Perspective (Pers = 0 to 100)
1104 1105	Picture-in-picture (skew) F1: Expansion and reduction along X-axis (Size_X = Small to 3 times) F2: Expansion and reduction along Y-axis (Size_Y = Small to 3 times) F3: Degree of distortion along X-axis (Skew_X = Min: No distortion) (default) F4: Degree of distortion along Y-axis (Skew_Y = Min: No distortion) (default)
1120 to 1128	Picture-in-picture F2: Display position (POS = TOP_L/TOP/R/LEFT/CENTER/RIGHT/BTM_L/BOTTOM/BTM_R) F3: Picture size (Size = 0 to 100) F4: X-axis picture position (Pos_X = -100 to +100) F5: Y-axis picture position (Pos_Y = -100 to +100)
1150 1151	Spotlight F1: Spotlight brightness at maximum fader lever position (Shadow = Dark to bright) F4: Aspect ratio of the processing area (Aspect = Taller to wider)
1210 to 1213	Stream F1: Stream direction (Dirctn)
1250 to 1253 1270 1271	Wave modulation F1: Degree of modification 1 (Amp_X = 0 to 100) (1250: Modification along X-axis) F2: Degree of modification 2 (1250: Amp_Y = 0 to 100) (1251/1271: Angle = 0 to 99) 1250: Modification along Y-axis 1251, 1271: Direction of modification 1252, 1253, 1270: Not used F3: Wave cycle (Freq = 0 to 100) F4: Wave speed (Speed = 0 to 100)

(continued)

Effect control parameters (continued)

Pattern No.	Effect type and adjustable parameters
1280 to 1283 1285 1286	Real paint, Stained glass F1: Degree of paint effect (Amp = 0 to 100) F2: Frames per second (Strobe = 0 to 100) F3: Softness (Soft = 0 to 100) F4: Mask pattern (MASK = OFF/CIRCLE/RECT/CIRINV/RECINV) F5: Aspect ratio of the mask area (MskAsp = Taller to wider)
1380 to 1383 1385 to 1388	Split slide F1: Slide frequency (Freq = 0 to 100) F2: Split frequency (Angle = 0 to 99) F3: Z-axis rotation (Rot_Z = -100 to +100)
1390 to 1394	Split slide F1: Slide frequency (Freq = 0 to 100)
1690	2D rotation + Compress + Slide (modified) F1: Amount of curving (Curve = 0 to 100) F2: Curve direction (Angle = 0 to 99) F3: Amount of spiral (Spiral = -100 to +100) F4: Z-axis rotation (Rot_Z = -100 to +100)
1750 to 1753	Split 3D rotation F1: Number of split (Freq = 0 to 100)
2150 to 2154	Page turn F1: Direction of turn (Angle = 0 to 99) F2: Change in turn direction (Curve = -100 to +100)
2160 to 2167	Split page turn F1: Number of split (Freq = 0 to 100)
2250 2251	Picture-in-picture (sphere) F1: Degree of modification (Amp = 0 to 100) F2: Z-axis rotation (Rot_Z = -100 to +100) F3: X-axis mapping area (Area_X = 0 to 100) F4: Y-axis mapping area (Area_Y = 0 to 100)

(continued)

Appendixes

Appendixes

Effect Control Parameter List

Effect control parameters (continued)

Pattern No.	Effect type and adjustable parameters
2260 to 2269	Ripple F1: Amplitude of modulation (Amp = 0 to 100) F2: Frequency of modulation (Freq = 0 to 100) F3: Speed of modulation (Speed = -100 to +100) (2260 to 2265 only) or area of modulation (Area = -100 to +100) (2266, 2267) F4: Aspect ratio of modulation (Aspect = 0 to 100) F5: Direction of modulation (Angle = 0 to 99) F6: Swirl modulation selection (SPMOD = OFF, IN, OUT) (2260 to 2265 only) F7: Degree of swirl modulation (Spiral = 0 to 100) (2260 to 2265 only)
2270 to 2271	Burst F1: Degree of splitting (Freq = 0 to 100) F2: Rotation around Z axis (Rot = -100 to +100) F3: Degree of modulation (Spiral = -100 to +100) (2270) or area of modulation (Area = 0 to 100) (2271) F4: Form of modulation (FORM = RANDAM/CONST/WAVE1/WAVE2/LINE1/LINE2/PIXEL1/P1XEL2)
2272	Broken glass F1: Degree of splitting (Freq = 0 to 100) F2: Rotation around Z axis (Rot = -100 to +100) F3: Splitting adjustment (Split = 0 to 100)
2273	Explosion F1: Stream area (AREA = NARROW/MEDIUM/WIDE/SPWIDE) F2: Form of modulation (FORM = RANDAM/PIXEL/LINE/WAVE1/WAVE2/WAVE3/WAVE4/CONST) F3: Degree of swirl modulation (Spiral = -100 to +100) F4: Modulation aspect ratio (Aspect = Taller to wider) F5: Direction of modulation (Angle = 0 to 99)
2274	Ring F1: Amplitude of modulation (Amp = -100 to +100) F2: Degree of splitting (Freq = 0 to 100) F4: Modulation aspect ratio (Aspect = Taller to wider) F5: Direction of modulation (Angle = 0 to 99)
2275 to 2277	Swirl F1: Amplitude of modulation (Amp = -100 to +100) F4: Modulation aspect ratio (Aspect = Taller to wider) F5: Direction of modulation (Angle = 0 to 99)
2278	Swirl (soft rotation)
2279	F1: Degree of modulation (Soft = 0 to 100)
2280	Amoeba F2: Fineness of modulation (Freq = 0 to 100)
2283	Meltdown F1: Form of modulation (FORM = WAVE1/RAND1/WAVE2/RAND2) F2: Direction of modulation (TRANS = NORM1/NORM2/REV1/REV2)

(continued)

Effect control parameters (continued)

Pattern No.	Effect type and adjustable parameters
2284	Lens F1: Amplitude of modulation (Amp = 0 to 100) F2: Size of lens (Size = 0 to 100) F3: Form of lens (FORM = FLAT/INNER/OUTER/SPHERE) F4: Modulation aspect ratio (Aspect = Taller to wider) F5: Direction of modulation (Angle = 0 to 99)
2400 to 2407 to 2410 to 2419	Two-picture brick F1: Depth (Depth = 0 to 100) F3: Stretching of picture in depth section (Strch = 0 to 100) F4: Position of picture in depth section (Posi = -100 to +100)
2420 to 2437	Two-picture brick (flip type) F1: Depth (Depth = 0 to 100) F2: Form model (FORM = SLAB/DUAL) F3: Stretching of picture in depth section (Strch = 0 to 100) F4: Position of picture in depth section (Posi = -100 to +100)
2470 to 2473	Split 3D rotation F1: Fineness of splitting (Freq = 0 to 100)
2480 to 2489	Masked flip F1: Mask shape (PATTERN = CIRCLE/HEART/RECT/DIA/HEXA/5STAR/6STAR/WAVE) F2: Fineness of splitting (Freq = 0 to 100) F3: Bias of splitting (Bias = 0 to 100)
2490 to 2499	Masked flip F1: Mask shape (PATTERN = CHECK1/CHECK2/CHECK3/CHECK4/CHECK5/LINE/RECT1/RECT2) F2: Mask slant (SLANT = ON/OFF)
2501 to 2507	2ch picture-in-picture F1: Timing at which picture appears (Delay = 0 to 100) F2: Picture position (POSITN = HORZ1/HORZ2/HORZ3/VERT1/VERT2/VERT3/DIAG1/DIAG2) F3: Picture size (Size = 0 to 100) F4: Relative position on X axis (Gap_X = 0 to 100) F5: Relative position on Y axis (Gap_Y = 0 to 100)
2508 to 2509	2ch picture-in-picture F2: Picture position (POSITN = HORZ1/HORZ2/HORZ3/VERT1/VERT2/VERT3/DIAG1/DIAG2) F3: Picture size (Size = 0 to 100) F4: Relative position on X axis (Gap_X = 0 to 100) F5: Relative position on Y axis (Gap_Y = 0 to 100)

(continued)



Effect Control Parameter List



Appendix

Effect control parameters (continued)

Pattern No.	Effect type and adjustable parameters
2510 to 2513	2ch picture-in-picture (with perspective, horizontal alignment) F1: Perspective (Pers = 0 to 100) F2: Y-axis size (Size_Y = 0 to 100) F3: Y-axis position (Pos_Y = 0 to 100) F4: X-axis size (Size_X = 0 to 100) F5: Relative position on X axis (Gap_X = 0 to 100)
2514 to 2517	2ch picture-in-picture (with perspective, vertical alignment) F1: Perspective (Pers = 0 to 100) F2: X-axis size (Size_X = 0 to 100) F3: X-axis position (Pos_X = 0 to 100) F4: Y-axis size (Size_Y = 0 to 100) F5: Relative position on Y axis (Gap_Y = 0 to 100)
2518	2ch picture-in-picture (manual) F1: X-axis rotation (Rot_X = -100 to +100) F2: Y-axis rotation (Rot_Y = -100 to +100) F3: Z-axis rotation (Rot_Z = -100 to +100) F4: Perspective (Pers = 0 to 100) F5: Form of picture (PTN = RECT/CIRCLE/HEART/DIA/PENTA/HEXA/5STAR/6STAR) F6: Direction of X-axis rotation (SYM RX X = ON/OFF) F7: Direction of Y-axis rotation (SYM RY Y = ON/OFF) F8: Direction of Z-axis rotation (SYM RZ Z = ON/OFF) F11: Relative position on X axis (Loc_X2 = -100 to +100) F12: Relative position on Y axis (Loc_Y2 = -100 to +100) F13: Relative position on z axis (Loc_Z2 = -100 to +100) F14: Two-picture combination type (COMBIN = ZLOC/CH1/CH2/MIX)
2519	2ch picture-in-picture (manual) F1: X-axis rotation (CH1) (Rot_X1 = -100 to +100) F2: Y-axis rotation (CH1) (Rot_Y1 = -100 to +100) F3: Z-axis rotation (CH1) (Rot_Z1 = -100 to +100) F4: Perspective (Pers = 0 to 100) F5: Form of picture (PTN = RECT/CIRCLE/HEART/DIA) F6: X-axis rotation (CH2) (Rot_X2 = -100 to +100) F7: Y-axis rotation (CH2) (Rot_Y2 = -100 to +100) F8: Z-axis rotation (CH2) (Rot_Z2 = -100 to +100) F11: X-axis position (CH2) (Loc_X2 = -100 to +100) F12: Y-axis position (CH2) (Loc_Y2 = -100 to +100) F13: Z-axis position (CH2) (Loc_Z2 = -100 to +100) F14: Two-picture combination type (COMBIN = ZLOC/CH1/CH2/MIX)
2520	2ch picture-in-picture F1: Delay between channels (Delay = 0 to 100)

(continued)

Effect control parameters (continued)

Pattern No.	Effect type and adjustable parameters
2521	2ch picture-in-picture (slide) F1: Delay between channels (Delay = 0 to 100) F2: Direction of picture movement (CH1) (1CHDIR = LEFT/RIGHT/TOP/BOTTOM/BTM-R/BTM-L/TOP-L/TOP-R) F3: Direction of picture movement (CH2) (2CHDIR = LEFT/RIGHT/TOP/BOTTOM/BTM-R/BTM-L/TOP-L/TOP-R)
2522	2ch picture-in-picture F1: Delay between channels (Delay = 0 to 100) F2: Direction of picture movement (CH1) (1CHDIR = LEFT/RIGHT/TOP/BOTTOM/BTM-R/BTM-L/TOP-L/TOP-R) F3: Direction of picture movement (CH2) (2CHDIR = LEFT/RIGHT/TOP/BOTTOM/BTM-R/BTM-L/TOP-L/TOP-R)
2523	2ch picture-in-picture (compressed, expanded)
2524	F1: Delay between channels (Delay = 0 to 100) F2: Direction of picture movement (CH1) (1CHDIR = LEFT/RIGHT/TOP/BOTTOM/HORZ/VERT) F3: Direction of picture movement (CH2) (2CHDIR = LEFT/RIGHT/TOP/BOTTOM/HORZ/VERT)
2525	2ch picture-in-picture F1: Delay between channels (Delay = 0 to 100) F2: Direction of picture movement (CH1) (1CHDIR = LEFT/RIGHT/TOP/BOTTOM) F3: Direction of picture movement (CH2) (2CHDIR = LEFT/RIGHT/TOP/BOTTOM) F4: Direction of effect (CH1) (1chAng = -100 to +100) F5: Direction of effect (CH2) (2chAng = -100 to +100)
2526	2ch picture-in-picture F1: Delay between channels (Delay = 0 to 100) F2: Direction of picture movement (CH1) (1CHROT = TOP-L1/ TOP-L2/ TOP-R1 /TOP-R2/BTM-R1/ BTM-R2/BTM-L1/ BTM-L2) F3: Direction of picture movement (CH2) (2CHROT = TOP-L1/ TOP-L2/ TOP-R1 /TOP-R2/BTM-R1/ BTM-R2/BTM-L1/ BTM-L2)
2527	2ch picture-in-picture F1: Delay between channels (Delay = 0 to 100) F2: Direction of picture movement (CH1) (1CHROT = TOP1/ TOP2/ BTM1/ BTM2/LEFT1/LEFT2/RIGHT1/RIGHT2) F3: Direction of picture movement (CH2) (2CHROT = TOP1/ TOP2/ BTM1/ BTM2/LEFT1/LEFT2/RIGHT1/RIGHT2)
2530	2ch picture-in-picture
2531	F1: Delay between channels (Delay = 0 to 100) F2: Direction of picture movement (CH1) (ROTDIR = PLUS/MINUS) F3: Perspective (Pers = 0 to 100)
2532	2ch picture-in-picture F1: Delay between channels (Delay = 0 to 100) F2: Speed of rotation (Rot = -100 to +100)

(continued)

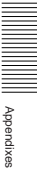

Appendix

Effect Control Parameter List

Effect control parameters (continued)

Pattern No.	Effect type and adjustable parameters
2533	2ch picture-in-picture
2534	F1: Delay between channels (Delay = 0 to 100) F2: Speed of rotation (Rot = -100 to +100) F3: Perspective (Pers = 0 to 100)
2550 to 2554	Two-picture (front, reverse) page turn F1: Direction of turn (Angle = 0 to 99) F2: Change in turn direction (Curve = -100 to +100)
2560 to 2564	Split page turn F1: Direction of turn (Angle = 0 to 99) F2: Change in turn direction (Curve = -100 to +100) F3: Type of turn (DIVTYP = VERT1/VERT2/HORZ1/HORZ2)
2624	3D split
2625	F1: Speed at which cracks spread (Speed = 0 to 100) F2: Degree to which fragments fly away (Fly = 0 to 100) X/Y: Move the break center point
2630	3D split flip
2631	F1: Direction of flip (Angle = 0 to 99) F2: Area of the part that flips (Area = 0 to 100) F3: Amount of randomness in flip (Rand = 0 to 100) F4: X direction divisions (Div_X = 1 to 16) F5: Y direction divisions (Div_Y = 1 to 16) F6: Amount of X-axis rotation (Rot_X = -100 to +100) F7: Amount of Y-axis rotation (Rot_Y = -100 to +100) F8: Amount of Z-axis rotation (Rot_Z = -100 to +100) F9: Perspective (Pers = 0 to 100) F10: Delay before start of flip (Delay = -100 to +100) X/Y/Z: Location, enlargement, and reduction of the pattern
2632	3D split flip
2633	F1: Direction of split (Angle = 0 to 99) F2: Change in direction of split (Curve = -100 to +100) F3: Area of the part that splits (Area = 0 to 100) F4: Split frequency (Freq = 0 to 100) F6: Amount of X-axis rotation (Rot_X = -100 to +100) F7: Amount of Y-axis rotation (Rot_Y = -100 to +100) F8: Amount of Z-axis rotation (Rot_Z = -100 to +100) F9: Perspective (Pers = 0 to 100) F10: Delay before start of split (Delay = -100 to +100) X/Y/Z: Location, enlargement, and reduction of the pattern
2690	Special wipe F1: Width of crystal (Width = 0 to 100) F2: Angle of wipe (Angle = 0 to 99) F3: Refractive index of crystal (Refract = 0 to 100)
2691	Special wipe
2692	F1: Angle of wipe (Angle = 0 to 99) F2: Degree of edge curve (Angle = 0 to 99) X/Y: Move the center point

(continued)

Effect control parameters (continued)

Pattern No.	Effect type and adjustable parameters
2700	3D page turn
2701	F1: Direction of turn (Angle = 0 to 99) F2: Change in turn direction (Curve = -100 to +100) F3: Radius of turn (Radius = 0 to 100) F4: Adjustment of effect end position (EndAdj= -100 to +100) F6: Amount of X-axis rotation (Rot_X = -100 to +100) F7: Amount of Y-axis rotation (Rot_Y = -100 to +100) F8: Amount of Z-axis rotation (Rot_Z = -100 to +100) F9: Perspective (Pers = 0 to 100) F10: Delay before start of turn (Delay = -100 to +100) X/Y/Z: Location, enlargement, and reduction of the pattern
2702	3D page turn
2703	F1: Direction of turn (Angle = 0 to 99) F2: Change in turn direction (Curve = -100 to +100) F3: Radius of turn (Radius = 0 to 100) F4: Adjustment of effect end position (EndAdj= -100 to +100) F5: Type of division (TYPE = HORZ1/HORZ2/VERT1/VERT2) F6: Amount of X-axis rotation (Rot_X = -100 to +100) F7: Amount of Y-axis rotation (Rot_Y = -100 to +100) F8: Amount of Z-axis rotation (Rot_Z = -100 to +100) F9: Perspective (Pers = 0 to 100) F10: Delay before start of turn (Delay = -100 to +100) X/Y/Z: Location, enlargement, and reduction of the pattern
2704	3D page turn
2705	F1: Direction of turn (Angle = 0 to 99) F2: Spread in turn direction (Spread = -100 to +100) F3: Radius of turn (Radius = 0 to 100) F4: Adjustment of effect end position (EndAdj= -100 to +100) F5: Type of division (TYPE = HORZ/VERT) F6: Amount of X-axis rotation (Rot_X = -100 to +100) F7: Amount of Y-axis rotation (Rot_Y = -100 to +100) F8: Amount of Z-axis rotation (Rot_Z = -100 to +100) F9: Perspective (Pers = 0 to 100) F10: Delay before start of turn (Delay = -100 to +100) X/Y/Z: Location, enlargement, and reduction of the pattern

(continued)

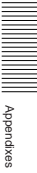

Effect Control Parameter List

Effect control parameters (continued)

Pattern No.	Effect type and adjustable parameters
2710	3D page turn
2711	F1: Direction of turn (Angle = 0 to 100) F2: Change in turn direction (Curve = -100 to +100) F3: Radius of turn (Radius = 0 to 100) F4: Adjustment of effect end position (EndAdj = -100 to +100) F6: Amount of X-axis rotation (Rot_X = -100 to +100) F7: Amount of Y-axis rotation (Rot_Y = -100 to +100) F8: Amount of Z-axis rotation (Rot_Z = -100 to +100) F9: Perspective (Pers = 0 to 100) F10: Delay before start of turn (Delay = -100 to +100) X/Y/Z: Location, enlargement, and reduction of the pattern
2712	3D page turn
2713	F3: Radius of turn (Radius = 0 to 100) F4: Adjustment of effect end position (EndAdj = -100 to +100) F6: Amount of X-axis rotation (Rot_X = -100 to +100) F7: Amount of Y-axis rotation (Rot_Y = -100 to +100) F8: Amount of Z-axis rotation (Rot_Z = -100 to +100) F9: Perspective (Pers = 0 to 100) F10: Delay before start of turn (Delay = -100 to +100) X/Y/Z: Location, enlargement, and reduction of the pattern
2714	3D page turn
2715	F3: Radius of turn (Radius = 0 to 100) F4: Adjustment of effect end position (EndAdj = -100 to +100) F6: Amount of X-axis rotation (Rot_X = -100 to +100) F7: Amount of Y-axis rotation (Rot_Y = -100 to +100) F8: Amount of Z-axis rotation (Rot_Z = -100 to +100) F9: Perspective (Pers = 0 to 100) F10: Delay before start of turn (Delay = -100 to +100) X/Y/Z: Location, enlargement, and reduction of the pattern
2720	3D twist F1: Direction of twist (Angle = 0 to 99) F2: Change in twist direction (Curve = -100 to +100) F3: Area of the part that twists (Area = 0 to 100) F6: Amount of X-axis rotation (Rot_X = -100 to +100) F7: Amount of Y-axis rotation (Rot_Y = -100 to +100) F8: Amount of Z-axis rotation (Rot_Z = -100 to +100) F9: Perspective (Pers = 0 to 100) F10: Delay before start of twist (Delay = -100 to +100) X/Y/Z: Location, enlargement, and reduction of the pattern
2721 to 2724	3D twist F3: Area of the part that twists (Area = 0 to 100) F4: Type of twist (TYPE = TYPE01/TYPE02/TYPE03/TYPE04) F6: Amount of X-axis rotation (Rot_X = -100 to +100) F7: Amount of Y-axis rotation (Rot_Y = -100 to +100) F8: Amount of Z-axis rotation (Rot_Z = -100 to +100) F9: Perspective (Pers = 0 to 100) F10: Delay before start of twist (Delay = -100 to +100) X/Y/Z: Location, enlargement, and reduction of the pattern

(continued)

Effect control parameters (continued)

Pattern No.	Effect type and adjustable parameters
2730	3D box twist
2739	F3: Area of the part that twists (Area = 0 to 100) F4: Type of twist (TYPE = TYPE01/TYPE02/TYPE03/TYPE04) F5: Delay before start of twist (Delay = -100 to +100) X/Y/Z: Location, enlargement, and reduction of the pattern
2750	3D modeling effect F1: Amplitude of swirl (Amp = 0 to 100) F2: X-axis rotation of path into swirl (Path_X = -100 to +100) F3: Y-axis rotation of path into swirl (Path_Y = -100 to +100) F4: Z-axis rotation of path into swirl (Path_Z = -100 to +100)
2800 to 2805	3D beveled edge, Picture-in-picture F1: Amount of X-axis rotation (Rot_X = -100 to +100) F2: Amount of Y-axis rotation (Rot_Y = -100 to +100) F3: Amount of Z-axis rotation (Rot_Z = -100 to +100) F4: Perspective (Pers = 0 to 100) F5: Bevel frame type (TYPE = TYPE01 to TYPE10) F6: Width of frame (Width = 0 to 100) F10: Position of light source (Light = -100 to +100) X/Y/Z: Location, enlargement, and reduction of the pattern
2810 to 2813	3D modeled edge, Picture-in-picture F1: Amount of X-axis rotation (Rot_X = -100 to +100) F2: Amount of Y-axis rotation (Rot_Y = -100 to +100) F3: Amount of Z-axis rotation (Rot_Z = -100 to +100) F4: Perspective (Pers = 0 to 100) F5: Border frame type (TYPE = TYPE01 to TYPE04) F6: Width of frame (Width = 0 to 100) F7: Length of protruding part of frame (Length = 0 to 100) F8: Sharpness of frame edges (Sharp = 0 to 100)(2810 and 2811 only) F9: Position in the depth direction of the picture (Depth = 0 to 100) F10: Position of light source (Light = -100 to +100) X/Y/Z: Location, enlargement, and reduction of the pattern

(continued)

Appendixes

Appendixes

Effect Control Parameter List

Effect control parameters (continued)

Pattern No.	Effect type and adjustable parameters
2820	3D two-picture cube
2821	F1: Amount of X-axis rotation (Rot_X = -100 to +100) F2: Amount of Y-axis rotation (Rot_Y = -100 to +100) F3: Amount of Z-axis rotation (Rot_Z = -100 to +100) F4: Perspective (Pers = 0 to 100) F5: Frame type (TYPE = TYPE01 to TYPE04/OFF) F6: Cube degree (Cube = 0 to 100) F7: Stretching of picture in X-axis direction (Strtch = 0 to 100) F8: Position in X-axis direction (Posi = -100 to +100) F9: Width of frame (Width = 0 to 100) F10: Position of light source (Light = -100 to +100) F11: Amount of X-axis auto rotation (Spd_X = -100 to +100) F12: Amount of Y-axis auto rotation (Spd_Y = -100 to +100) F13: Amount of Z-axis auto rotation (Spd_Z = -100 to +100) X/Y/Z: Location, enlargement, and reduction of the pattern
2822	3D one-picture cube
2823	F1: Amount of X-axis rotation (Rot_X = -100 to +100) F2: Amount of Y-axis rotation (Rot_Y = -100 to +100) F3: Amount of Z-axis rotation (Rot_Z = -100 to +100) F4: Perspective (Pers = 0 to 100) F5: Frame type (TYPE = TYPE01 to TYPE04/OFF) F6: Cube degree (Cube = 0 to 100) F7: Stretching of picture in X-axis direction (Strtch = 0 to 100) F8: Position in X-axis direction (Posi = -100 to +100) F9: Width of frame (Width = 0 to 100) F10: Position of light source (Light = -100 to +100) F11: Amount of X-axis auto rotation (Spd_X = -100 to +100) F12: Amount of Y-axis auto rotation (Spd_Y = -100 to +100) F13: Amount of Z-axis auto rotation (Spd_Z = -100 to +100) X/Y/Z: Location, enlargement, and reduction of the pattern
2824	3D two-picture brick
2825	F1: Amount of X-axis rotation (Rot_X = -100 to +100) F2: Amount of Y-axis rotation (Rot_Y = -100 to +100) F3: Amount of Z-axis rotation (Rot_Z = -100 to +100) F4: Perspective (Pers = 0 to 100) F5: Frame type (TYPE = TYPE01 to TYPE04/OFF) F6: Height of brick (Hight = 0 to 100) F7: Stretching of brick side in Y-axis direction (Strtch = 0 to +100) F8: Position of brick side in Y-axis direction (Posi = -100 to +100) F9: Width of frame (Width = 0 to 100) F10: Position of light source (Light = -100 to +100) F11: Amount of X-axis auto rotation (Spd_X = -100 to +100) F12: Amount of Y-axis auto rotation (Spd_Y = -100 to +100) F13: Amount of Z-axis auto rotation (Spd_Z = -100 to +100) X/Y/Z: Location, enlargement, and reduction of the pattern

(continued)

Effect control parameters (continued)

Pattern No.	Effect type and adjustable parameters
2826	3D one-picture brick
2827	F1: Amount of X-axis rotation (Rot_X = -100 to +100) F2: Amount of Y-axis rotation (Rot_Y = -100 to +100) F3: Amount of Z-axis rotation (Rot_Z = -100 to +100) F4: Perspective (Pers = 0 to 100) F5: Frame type (TYPE = TYPE01 to TYPE04) F6: Height of brick (Hight = 0 to 100) F7: Stretching of brick side in Y-axis direction (Strtch = 0 to 100) F8: Position of brick side in Y-axis direction (Posi = -100 to +100) F9: Width of frame (Width = 0 to 100) F10: Position of light source (Light = -100 to +100) F11: Amount of X-axis auto rotation (Spd_X = -100 to +100) F12: Amount of Y-axis auto rotation (Spd_Y = -100 to +100) F13: Amount of Z-axis auto rotation (Spd_Z = -100 to +100) X/Y/Z: Location, enlargement, and reduction of the pattern
2830	3D three-picture cube
2831	F1: Amount of X-axis rotation (Rot_X = -100 to +100) F2: Amount of Y-axis rotation (Rot_Y = -100 to +100) F3: Amount of Z-axis rotation (Rot_Z = -100 to +100) F4: Perspective (Pers = 0 to 100) F5: Frame type (TYPE = TYPE01 to TYPE04/OFF) F6: Cube degree (Cube = 0 to 100) F7: Stretching of picture in X-axis direction (Strtch = 0 to 100) F8: Position in X-axis direction (Posi = -100 to +100) F9: Width of frame (Width = 0 to 100) F10: Position of light source (Light = -100 to +100) F11: Amount of X-axis auto rotation (Spd_X = -100 to +100) F12: Amount of Y-axis auto rotation (Spd_Y = -100 to +100) F13: Amount of Z-axis auto rotation (Spd_Z = -100 to +100) X/Y/Z: Location, enlargement, and reduction of the pattern
2832	3D two-picture cube
2833	F1: Amount of X-axis rotation (Rot_X = -100 to +100) F2: Amount of Y-axis rotation (Rot_Y = -100 to +100) F3: Amount of Z-axis rotation (Rot_Z = -100 to +100) F4: Perspective (Pers = 0 to 100) F5: Frame type (TYPE = TYPE01 to TYPE04/OFF) F6: Cube degree (Cube = 0 to 100) F7: Stretching of picture in X-axis direction (Strtch = 0 to 100) F8: Position in X-axis direction (Posi = -100 to +100) F9: Width of frame (Width = 0 to 100) F10: Position of light source (Light = -100 to +100) F11: Amount of X-axis auto rotation (Spd_X = -100 to +100) F12: Amount of Y-axis auto rotation (Spd_Y = -100 to +100) F13: Amount of Z-axis auto rotation (Spd_Z = -100 to +100) X/Y/Z: Location, enlargement, and reduction of the pattern

(continued)

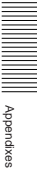

Effect Control Parameter List

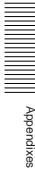

Appendixes

Effect control parameters (continued)

Pattern No.	Effect type and adjustable parameters
2840	3D cylinder
2841	F1: Amount of X-axis rotation (Rot_X = -100 to +100) F2: Amount of Y-axis rotation (Rot_Y = -100 to +100) F3: Amount of Z-axis rotation (Rot_Z = -100 to +100) F4: Fine adjustment of mapping in X-axis direction (Area_X = 0 to 100) F5: Fine adjustment of mapping in Y-axis direction (Area_Y = 0 to 100) F6: Thickness of cylinder (Radius = 0 to 100) F7: Degree of wave modulation on cylinder sides (Amp = 0 to 100) F8: Frequency of wave modulation on cylinder sides (Freq = 0 to 100) F9: Phase of wave modulation on cylinder sides (Phase = 0 to 99) F10: Position of light source (Light = -100 to +100) F11: Amount of X-axis auto rotation (Spd_X = -100 to +100) F12: Amount of Y-axis auto rotation (Spd_Y = -100 to +100) F13: Amount of Z-axis auto rotation (Spd_Z = -100 to +100) X/Y/Z: Location, enlargement, and reduction of the pattern
2842 to 2845	Sphere, Heart F1: Amount of X-axis rotation (Rot_X = -100 to +100) F2: Amount of Y-axis rotation (Rot_Y = -100 to +100) F3: Amount of Z-axis rotation (Rot_Z = -100 to +100) F4: Fine adjustment of mapping in X-axis direction (Area_X = 0 to 100) F5: Fine adjustment of mapping in Y-axis direction (Area_Y = 0 to 100) F6: Amount of X-axis auto rotation (Spd_X = -100 to +100) F7: Amount of Y-axis auto rotation (Spd_Y = -100 to +100) F8: Amount of Z-axis auto rotation (Spd_Z = -100 to +100) F10: Position of light source (Light = -100 to +100) X/Y/Z: Location, enlargement, and reduction of the pattern
2850 to 2853	3D wave F1: Amount of X-axis rotation (Rot_X = -100 to +100) F2: Amount of Y-axis rotation (Rot_Y = -100 to +100) F3: Amount of Z-axis rotation (Rot_Z = -100 to +100) F4: Perspective (Pers = 0 to 100) F5: Direction of wave modulation (Angle = 0 to 99) F6: Amplitude of wave modulation (Amp = 0 to 100) F7: Frequency of wave modulation (Freq = 0 to 100) F8: Phase of wave modulation (Phase = 0 to 99) F9: Speed of auto change in phase of wave modulation (Speed = -100 to +100) F10: Position of light source (Light = -100 to +100) X/Y/Z: Location, enlargement, and reduction of the pattern

(continued)

Effect control parameters (continued)

Pattern No.	Effect type and adjustable parameters
2854	3D wave
2855	F1: Amount of X-axis rotation (Rot_X = -100 to +100) F2: Amount of Y-axis rotation (Rot_Y = -100 to +100) F3: Amount of Z-axis rotation (Rot_Z = -100 to +100) F4: Perspective (Pers = 0 to 100) F5: Direction of wave modulation (Angle = 0 to 99) F6: Amplitude of wave modulation 1 (Amp1 = 0 to 100) F7: Frequency of wave modulation 1 (Freq1 = 0 to 100) F8: Phase of wave modulation 1 (Phase1 = 0 to 99) F9: Speed of auto change in phase of wave modulation 1 (Speed1 = -100 to +100) F10: Position of light source (Light = -100 to +100) F11: Amplitude of wave modulation 2 (Amp2 = 0 to 100) F12: Frequency of wave modulation 2 (Freq2 = 0 to 100) F13: Phase of wave modulation 2 (Phase2 = 0 to 99) F14: Speed of auto change in phase of wave modulation 2 (Speed2 = -100 to +100) X/Y/Z: Location, enlargement, and reduction of the pattern
2856	3D flag
2857	F1: Amount of X-axis rotation (Rot_X = -100 to +100) F2: Amount of Y-axis rotation (Rot_Y = -100 to +100) F3: Amount of Z-axis rotation (Rot_Z = -100 to +100) F4: Perspective (Pers = 0 to 100) F5: Position of pole (POLE = RIGHT/LEFT) F6: Amplitude of wave modulation (Amp = 0 to 100) F7: Change in direction of waving (Swing = 0 to 100) X/Y/Z: Location, enlargement, and reduction of the pattern
2860	Kaleidoscope F1: Size of repetition (Size = 0 to 100) F2: Amount of auto rotation (RotSpd = -100 to +100)
2865	3D crystal F1: Amount of auto repetition in X-axis rotation (Swng_X = 0 to 100) F2: Amount of auto repetition in Y-axis rotation (Swng_Y = 0 to 100) F3: Amount of auto rotation on Z-axis (Spd_Z = -100 to +100) F4: Width of beveled edge (Width = 0 to 100) F5: Height of beveled edge (Height = 0 to 100) X/Y/Z: Location, enlargement, and reduction of the pattern
2866	Mirror cube F1: Amount of auto rotation on X-axis (Spd_X = -100 to +100) F2: Amount of auto rotation on Y-axis (Spd_Y = -100 to +100) F3: Amount of auto rotation on Z-axis (Spd_Z = -100 to +100) X/Y/Z: Location, enlargement, and reduction of the pattern
2870	3D object effects F1: Mapping mode (MapMod = POINT/FACE1/FACE2)

(continued)

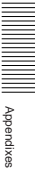

Appendixes

Effect Control Parameter List

Effect control parameters (continued)

Pattern No.	Effect type and adjustable parameters
2871	3D object effects
to	F1: Mapping mode (MapMod = POINT/FACE1/FACE2)
2876	F2: Size of model (Size = 0 to 100)
	F3: Acceleration of fall (Accel = 0 to 100)
	F4: Snaking on X-axis (Wave_X = 0 to 100)
	F5: Snaking on Y-axis (Wave_Y = 0 to 100)
	F6: Amount of auto rotation on X-axis (Spd_X = -100 to +100)
	F7: Amount of auto rotation on Y-axis (Spd_Y = -100 to +100)
	F8: Amount of auto rotation on Z-axis (Spd_Z = -100 to +100)
	F9: Frequency of snaking on X-axis (Freq_X = 0 to 100)
	X/Y/Z: Location, enlargement, and reduction of the pattern

Effect Motion Types

The effects of the DFS-700/700P can be classified by their direction type, as follows.

Effects classified by direction type

Direction type	Characteristics	Pattern No.
Transition type	When you move the fader from one end to the other and back, the effect is executed in the same direction. Crosspoints selected with the BACKGROUND and FOREGROUND bus buttons change when the effect is executed.	1 to 1000
		1003 to 1010 1059 1080 1200 to 1233 1260 to 1271 1300 to 2213 2260, 2261 2263, 2264 2266 to 2283 2300 to 2499 2550 to 2752 9000 to 9009 9200 to 9209
Animation type	<ul style="list-style-type: none"> When you move the fader from one end to the other and back, the effect is executed in the opposite direction. Crosspoints selected with the BACKGROUND and FOREGROUND bus buttons do not change. If the editing control unit select switch is set to PVE-500, the N/R button lights during execution of the effect. 	1001 1011 to 1058 1065 to 1079 1100 to 1151 1130 to 1171 1240 to 1253 1280 to 1288 2250 to 2251 2262 2265 2284 2500 to 2534 2800 to 2881 9100 to 9109 9300 to 9309

Effect Pattern Variant Forms and Decorations

Some effect patterns have attributes that allow you to change them, for example by changing the position or adding a border.

The following list shows the attributes that are available for each pattern.

TITLE: Title key transition
EDGE: Edge effects

BD: Border
 SF: Blurring
 BV: Bevel edge

CROP: Cropping

L: Left
 R: Right
 T: Top
 B: Bottom

LOCATE: Location of the pattern
 XY: X-axis and Y-axis location
 Z: Z-axis location

LIGHTING: Lighting
 SP: Spotlighting
 LN: Direct lighting
 PL: Even lighting

TRAIL: Trail
 TR: Trail
 DB: Drop border
 DS: Drop shadow

OPTION: Options
 711: The ☆ mark indicates that the BKDF-711 is required for this function.
 712: The ★ mark indicates that the BKDF-712 is required for this function.

Pattern No.	TITLE	EDGE			CROP				LOCATE		LIGHTING			TRAIL			OPTION	
		BD	SF	BV	L	R	T	B	XY	Z	SP	LN	PL	TR	DB	DS	711	712
0001 to 0016	√	√	√															
0017 to 0018	√	√	√					√										
0019 to 0020	√	√	√															
0021 to 0029	√	√	√					√										
0030 to 0033	√	√	√															
0034 to 0039	√	√	√					√										
0104 to 0676	√	√	√															
0700 to 0809	√	√	√										√	√	√			
1000	√	√	√	√									√	√	√			
1001	√	√	√	√									√	√	√			
1003 to 1010	√	√	√	√									√	√	√			
1011	√	√	√	√									√	√	√			
1015 to 1018	√	√	√					√	√				√	√	√			
1020 to 1027	√	√	√	√									√	√	√			
1030 to 1050	√	√	√	√									√	√	√			
1055 to 1058	√	√	√					√	√				√	√	√			
1059	√	√	√	√									√	√	√			
1065	√	√	√	√									√	√	√			
1066 to 1067	√	√	√					√					√	√	√			
1075 to 1079	√	√	√					√	√				√	√	√			
1080	√	√	√	√									√	√	√			
1100 to 1101	√	√	√	√	√	√	√	√	√				√	√	√			
1102 to 1105	√	√	√	√	√	√	√	√	√	√			√	√	√			
1106 to 1109	√	√	√	√	√	√	√	√	√	√			√	√	√			
1120 to 1128	√	√	√	√	√	√	√	√	√	√			√	√	√			
1130 to 1131	√	√	√	√	√	√	√	√	√	√			√	√	√			
1150 to 1151	√	√	√					√	√				√	√	√			
1200	√	√	√	√		√							√	√	√			
1201	√	√	√	√	√								√	√	√			

Pattern No.	TITLE	EDGE			CROP				LOCATE		LIGHTING			TRAIL			OPTION	
		BD	SF	BV	L	R	T	B	XY	Z	SP	LN	PL	TR	DB	DS	711	712
1202	√	√	√	√				√							√	√	√	
1203	√	√	√	√				√							√	√	√	
1204	√	√	√	√				√							√	√	√	
1205	√	√	√	√	√			√							√	√	√	
1206	√	√	√	√	√			√							√	√	√	
1207	√	√	√	√				√							√	√	√	
1210 and 1211	√	√	√	√				√	√						√	√	√	
1212 and 1213	√	√	√	√	√	√		√	√						√	√	√	
1230	√	√	√	√		√		√				√			√	√	√	
1231	√	√	√	√				√				√			√	√	√	
1232	√	√	√	√				√	√			√			√	√	√	
1233	√	√	√	√				√				√			√	√	√	
1240 and 1241	√	√	√	√	√	√		√	√			√	√		√	√	√	
1250	√	√	√	√	√	√		√	√			√			√	√	√	
1251	√	√	√	√	√	√		√	√			√	√		√	√	√	
1252 to 1253	√	√	√	√	√	√		√	√			√	√		√	√	√	
1260 to 1269	√	√	√	√	√	√		√	√			√	√		√	√	√	
1270 and 1271	√	√	√		√	√		√	√			√			√	√	√	
1280 to 1283	√	√	√					√	√			√	√		√	√	√	
1285 to 1288	√	√	√					√	√			√	√		√	√	√	
1300	√	√	√	√	√			√							√	√	√	
1301	√	√	√	√				√				√			√	√	√	
1302	√	√	√	√				√				√			√	√	√	
1303	√	√	√	√				√				√			√	√	√	
1304	√	√	√	√	√			√				√			√	√	√	
1305	√	√	√	√				√				√			√	√	√	
1306	√	√	√	√				√				√			√	√	√	
1307	√	√	√	√	√			√				√			√	√	√	
1330 to 1332	√	√	√	√	√			√				√			√	√	√	
1340	√	√	√	√	√			√				√			√	√	√	
1341	√	√	√	√				√				√			√	√	√	
1343	√	√	√	√				√				√			√	√	√	
1344	√	√	√	√				√				√			√	√	√	
1347	√	√	√	√				√				√	√		√	√	√	
1349	√	√	√	√	√			√				√			√	√	√	
1350 and 1351	√	√	√	√	√			√				√			√	√	√	
1360	√	√	√	√	√	√		√	√			√			√	√	√	
1361	√	√	√	√	√			√				√	√		√	√	√	
1362	√	√	√	√	√	√		√	√			√			√	√	√	
1363	√	√	√	√	√			√				√	√		√	√	√	
1370 and 1371	√	√	√	√	√	√		√	√			√			√	√	√	
1372 and 1373	√	√	√	√	√			√				√			√	√	√	
1380 to 1388	√	√	√	√	√	√		√	√			√			√	√	√	
1390	√	√	√	√	√	√		√	√			√			√	√	√	
1391	√	√	√	√	√	√		√	√			√			√	√	√	

Effect Pattern Variant Forms and Decorations

Pattern No.	TITLE	EDGE			CROP			LOCATE		LIGHTING			TRAIL			OPTION		
		BD	SF	BV	L	R	T	B	XY	Z	SP	LN	PL	TR	DB	DS	711	712
1392		√	√	√			√							√	√	√		
1393		√	√	√		√								√	√	√		
1394		√	√	√		√								√	√	√		
1500		√	√	√		√								√	√	√		
1501		√	√	√		√								√	√	√		
1502		√	√	√										√	√	√		
1503		√	√	√		√								√	√	√		
1504		√	√	√		√								√	√	√		
1505		√	√	√										√	√	√		
1506		√	√	√		√								√	√	√		
1507		√	√	√										√	√	√		
1508		√	√	√		√								√	√	√		
1510		√	√	√		√								√	√	√		
1511		√	√	√									√	√	√			
1512		√	√	√										√				
1513		√	√	√										√				
1514		√	√	√	√	√								√	√			
1515		√	√	√										√	√	√		
1520 to 1522		√	√	√										√	√	√		
1523		√	√	√		√								√	√	√		
1524		√	√	√										√	√	√		
1530 to 1535		√	√	√										√	√	√		
1600		√	√	√		√								√	√	√		
1601		√	√	√	√									√	√	√		
1602		√	√	√		√								√	√	√		
1603		√	√	√		√								√	√	√		
1604		√	√	√		√								√	√	√		
1605		√	√	√		√								√	√	√		
1606		√	√	√		√								√	√	√		
1607		√	√	√		√								√	√	√		
1610		√	√	√		√								√	√	√		
1611 and 1612		√	√	√	√	√								√	√	√		
1613		√	√	√		√								√	√	√		
1620 to 1644		√	√	√		√								√	√	√		
1690		√	√	√	√	√		√						√	√	√		
1700		√	√	√		√				√	√	√		√	√	√		
1701		√	√	√		√				√	√	√		√	√	√		
1702		√	√	√		√				√	√	√		√	√	√		
1703		√	√	√		√				√	√	√		√	√	√		
1704		√	√	√		√				√	√	√		√	√	√		
1705		√	√	√		√				√	√	√		√	√	√		
1706		√	√	√						√	√	√		√	√	√		
1707		√	√	√						√	√	√		√	√	√		
1730		√	√	√		√				√	√	√		√	√	√		
1731		√	√	√						√	√	√		√	√	√		



Pattern No.	TITLE	EDGE			CROP			LOCATE		LIGHTING			TRAIL			OPTION		
		BD	SF	BV	L	R	T	B	XY	Z	SP	LN	PL	TR	DB	DS	711	712
1732		√	√	√			√							√	√	√		
1740		√	√	√		√								√	√	√		
1741		√	√	√		√								√	√	√		
1742		√	√	√		√								√	√	√		
1750 to 1753		√	√	√		√								√	√	√		
1760 to 1770		√	√	√		√								√	√	√		
1780 to 1783		√	√	√		√								√	√	√		
1800 to 1806		√	√	√		√								√	√	√		
1807 to 1811		√	√	√		√								√	√	√		
1812 to 1816		√	√	√		√								√	√	√		
1820		√	√	√		√								√	√	√		
1821		√	√	√		√							√	√	√			
1822		√	√	√		√							√	√	√			
1823		√	√	√		√							√	√	√			
1824		√	√	√		√							√	√	√			
1850		√	√	√		√								√	√	√		
1851		√	√	√									√	√	√			
1852		√	√	√		√								√	√	√		
1853		√	√	√									√	√	√			
1854		√	√	√		√								√	√	√		
1855		√	√	√										√	√	√		
1900		√	√	√		√								√	√	√		
1901		√	√	√		√								√	√	√		
1902 to 1945		√	√	√		√								√	√	√		
1946		√	√	√		√								√	√	√		
1947		√	√	√		√								√	√	√		
1948		√	√	√		√								√	√	√		
1949 and 1950		√	√	√		√							√	√	√			
1951		√	√	√		√								√	√	√		
1952		√	√	√		√								√	√	√		
1954		√	√	√		√								√	√	√		
1955		√	√	√		√							√	√	√			
1956		√	√	√		√								√	√	√		
1958 and 1959		√	√	√		√								√	√	√		
1960 to 1964		√	√	√		√							√	√	√			
2000 to 2003		√	√	√		√							√	√	√			
2100		√	√	√		√								√	√	√		
2101		√	√	√		√							√	√	√			
2102		√	√	√		√							√	√	√			
2103		√	√	√		√								√	√	√		
2104		√	√	√		√							√	√	√			
2105		√	√	√		√								√	√	√		
2106		√	√	√		√							√	√	√			
2107		√	√	√		√							√	√	√			
2108		√	√	√		√							√	√	√			



Effect Pattern Variant Forms and Decorations



Appendix

Pattern No.	TITLE	EDGE			CROP				LOCATE		LIGHTING			TRAIL			OPTION	
		BD	SF	BV	L	R	T	B	XY	Z	SP	LN	PL	TR	DB	DS	711	712
2109		√	√	√	√	√	√				√	√	√	√	√			
2110		√	√	√	√	√	√				√	√	√	√	√			
2111		√	√	√	√	√	√				√	√	√	√	√			
2112		√	√	√	√	√	√				√	√	√	√	√			
2113		√	√	√	√	√	√				√	√	√	√	√			
2114		√	√	√	√	√	√				√	√	√	√	√			
2115 to 2120		√	√	√	√	√	√				√	√	√	√	√			
2121 to 2125		√	√	√	√	√	√				√	√	√	√	√			
2126		√	√	√	√	√	√				√	√	√	√	√			
2127 to 2144		√	√	√	√	√	√				√	√	√	√	√			
2150 to 2154		√	√	√	√	√	√				√	√	√	√	√			
2160		√	√	√	√	√	√				√	√	√	√	√			
2161 and 2162		√	√	√	√	√	√				√	√	√	√	√			
2163		√	√	√	√	√	√				√	√	√	√	√			
2164		√	√	√	√	√	√				√	√	√	√	√			
2165		√	√	√	√	√	√				√	√	√	√	√			
2166		√	√	√	√	√	√				√	√	√	√	√			
2167		√	√	√	√	√	√				√	√	√	√	√			
2200 to 2213		√	√	√	√	√	√				√	√	√	√	√			
2250 and 2251		√	√	√	√	√	√		√	√		√	√	√	√			
2260		√	√	√	√	√	√		√	√		√	√	√	√			
2261		√	√	√	√	√	√		√	√		√	√	√	√			
2262 and 2263		√	√	√	√	√	√		√	√		√	√	√	√			
2264		√	√	√	√	√	√		√	√		√	√	√	√			
2265 and 2266		√	√	√	√	√	√		√	√		√	√	√	√			
2267		√	√	√	√	√	√		√	√		√	√	√	√			
2268		√	√	√	√	√	√		√	√		√	√	√	√			
2269		√	√	√	√	√	√		√	√		√	√	√	√			
2270 to 2273		√	√	√	√	√	√		√	√		√	√	√	√			
2274		√	√	√	√	√	√		√	√		√	√	√	√			
2275 to 2278		√	√	√	√	√	√		√	√		√	√	√	√			
2279		√	√	√	√	√	√		√	√		√	√	√	√			
2280 and 2281		√	√	√	√	√	√		√	√		√	√	√	√			
2282		√	√	√	√	√	√		√	√		√	√	√	√			
2283		√	√	√	√	√	√		√	√		√	√	√	√			
2284								√	√		√							
2300		√	√	√	√	√	√					√	√	√	√	☆		
2301		√	√	√	√	√	√					√	√	√	√	☆		
2302		√	√	√	√	√	√					√	√	√	√	☆		
2303		√	√	√	√	√	√					√	√	√	√	☆		
2304 to 2307		√	√	√	√	√	√					√	√	√	√	☆		
2320		√	√	√	√	√	√					√	√	√	√	☆		
2321		√	√	√	√	√	√					√	√	√	√	☆		
2322 and 2323		√	√	√	√	√	√					√	√	√	√	☆		
2324		√	√	√	√	√	√					√	√	√	√	☆		

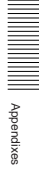

Appendix

Pattern No.	TITLE	EDGE			CROP				LOCATE		LIGHTING			TRAIL			OPTION	
		BD	SF	BV	L	R	T	B	XY	Z	SP	LN	PL	TR	DB	DS	711	712
2325		√	√	√	√	√	√							√	√	√	☆	
2326		√	√	√	√	√	√			√				√	√	√	☆	
2327		√	√	√	√	√	√							√	√	√	☆	
2328 and 2329		√	√	√	√	√	√			√				√	√	√	☆	
2340 to 2344		√	√	√	√	√	√			√				√	√	√	☆	
2345 and 2346		√	√	√	√	√	√			√	√			√	√	√	☆	
2347 and 2348		√	√	√	√	√	√			√	√			√	√	√	☆	
2349 and 2350		√	√	√	√	√	√			√	√	√		√	√	√	☆	
2351		√	√	√	√	√	√			√	√	√		√	√	√	☆	
2352 and 2353		√	√	√	√	√	√			√	√	√		√	√	√	☆	
2354 and 2355		√	√	√	√	√	√			√	√	√		√	√	√	☆	
2356 and 2357		√	√	√	√	√	√			√	√	√		√	√	√	☆	
2360 to 2375		√	√	√	√	√	√			√	√	√		√	√	√	☆	
2380 to 2395		√	√	√	√	√	√			√	√	√		√	√	√	☆	
2400 to 2419		√	√	√	√	√	√			√	√	√		√	√	√	☆	
2420 to 2427		√	√	√	√	√	√			√	√	√		√	√	√	☆	
2428 and 2429		√	√	√	√	√	√			√	√	√		√	√	√	☆	
2430 to 2437		√	√	√	√	√	√			√	√	√		√	√	√	☆	
2470 to 2473		√	√	√	√	√	√			√	√	√		√	√	√	☆	
2480 to 2483		√	√	√	√	√	√			√	√	√		√	√	√	☆	
2484 to 2499		√	√	√	√	√	√			√	√	√		√	√	√	☆	
2500		√	√	√	√	√	√							√	√	√	☆	
2501 to 2517		√	√	√	√	√	√							√	√	√	☆	
2518 to 2519		√	√	√	√	√	√		√	√				√	√	√	☆	
2520		√	√	√	√	√	√							√	√	√	☆	
2521 to 2523		√	√	√	√	√	√							√	√	√	☆	
2524 and 2525		√	√	√	√	√	√							√	√	√	☆	
2526 and 2527		√	√	√	√	√	√							√	√	√	☆	
2530 and 2531		√	√	√	√	√	√			√	√	√		√	√	√	☆	
2532		√	√	√	√	√	√							√	√	√	☆	
2533 and 2534		√	√	√	√	√	√			√	√	√		√	√	√	☆	
2550 to 2554		√	√	√	√	√	√						√	√	√	√	☆	
2560 to 2564		√	√	√	√	√	√					√		√	√	√	☆	
2600 to 2620		√	√	√	√	√	√							√	√	√		
2624		√	√	√	√	√	√			√				√	√	√	★	
2625										√	√			√	√	√	★	
2630 to 2633		√	√	√	√	√	√		√	√				√	√	√	★	
2640 to 2651		√	√	√	√	√	√							√	√	√	★	
2660 and 2661		√	√	√	√	√	√							√	√	√	★	
2690														√	√	√	★	
2691 and 2692		√	√	√	√	√	√			√				√	√	√	★	
2700 to 2715		√	√	√	√	√	√			√	√			√	√	√	★	
2720 to 2724		√	√	√	√	√	√			√	√	√		√	√	√	★	
2730 to 2739		√	√	√	√	√	√			√	√	√		√	√	√	★	
2740 to 2752		√	√	√	√	√	√			√	√	√		√	√	√	★	

Effect Pattern Variant Forms and Decorations

Pattern No.	TITLE	EDGE			CROP			LOCATE		LIGHTING			TRAIL			OPTION		
		BD	SF	BV	L	R	T	B	XY	Z	SP	LN	PL	TR	DB	DS	711	712
2800 to 2805		√	√	√	√	√	√	√	√	√				√	√	√		★
2810 to 2813		√	√	√	√	√	√	√	√	√				√	√	√		★
2820 to 2827		√	√	√	√	√	√	√	√	√				√	√	√		★
2830 to 2833		√	√	√	√	√	√	√	√	√				√	√	√	☆	★
2840 to 2845		√	√	√	√	√	√	√	√	√				√	√	√		★
2850 to 2857		√	√	√	√	√	√	√	√	√				√	√	√		★
2860 and 2861																		★
2865		√	√	√	√	√	√	√	√	√				√	√	√		★
2866														√	√	√		★
2870 to 2876														√	√	√		★
2880 and 2881														√	√	√		★
9000 to 9009	√	√	√	√	√	√	√	√	√	√				√	√	√		★
9100 to 9109	√	√	√	√	√	√	√	√	√	√				√	√	√		★
9200 to 9209	√	√	√	√	√	√	√	√	√	√		√		√	√	√		★
9300 to 9309	√	√	√	√	√	√	√	√	√	√				√	√	√		★

Effect Pattern Image List

This section illustrates the effect patterns of the DFS-700/700P.

How to read the patterns

Direction of the effect ^{a)}

Left and right mirror pictures

Upper and lower mirror pictures

a) Direction of the effect when executed in normal direction

Abbreviations in the illustrated patterns
 FG: Foreground picture
 BG: Background picture
 T: Transition type
 A: Animation type

Wipe									
1		2		3		4		5	
6		7		8		9		10	
11		12		13		14		15	
16		17		18		19		20	
21		22		23		24		26	
30		31		32		33			
104		105		106		107			

Effect Pattern Image List

Appendixes

Wipe (continued)														
310		T	311		T	312		T	313		T	320		T
321		T	323		T	324		T						
500		T	502		T	504		T	506		T	508		T
510		T	516		T	518		T	600		T	602		T
604		T	606		T	608		T	610		T	612		T
614		T	616		T	618		T	620		T	622		T
624		T	626		T	628		T	630		T	660		T
662		T	664		T	674		T	676		T			

Matrix wipe														
700		T	702		T	707		T	710		T	712		T
717		T	740		T	742		T	750		T	752		T
754		T	760	RANDOM	T	761	RANDOM	T	762	RANDOM	T	763	RANDOM	T
764	RANDOM	T	770		T			T	771		T			T

(continued)

Matrix wipe (continued)														
772				T	773				T					
774	RANDOM		RANDOM	T										
787		T	788		T	789		T	790		T	791		T
792		T	793		T	794		T	795		T	796		T
797		T	798		T	799			T	800	RANDOM	T		
808		T	809		T									

Mosaic											
1000	BG	BG MOSAIC(BXB)	FG MOSAIC(BXB)	FG	T	1001	FG	FG MOSAIC(BXB)			T
1003	BG	BG HORIZONTAL MOSAIC	FG HORIZONTAL MOSAIC	FG	T	1006	BG	BG VERTICAL MOSAIC	FG VERTICAL MOSAIC	FG	T
1010	BG	BG VARIABLE MOSAIC	FG VARIABLE MOSAIC	FG	T	1011	FG	FG VARIABLE MOSAIC			T
1015	BG FG VARIABLE MOSAIC	A	1016	BG FG VARIABLE MOSAIC	A	1017	FG BG VARIABLE MOSAIC	A	1018	FG BG VARIABLE MOSAIC	A

Appendixes

Effect Pattern Image List

Appendixes

Sill mirror					
1020	BG (DISSOLVE) $\begin{matrix} \text{FG} \\ \text{DR} \end{matrix}$	A	1021	BG (DISSOLVE) $\begin{matrix} \text{FG} \\ \text{DR} \end{matrix}$	A
1022	BG (DISSOLVE) $\begin{matrix} \text{EG} \\ \text{FG} \end{matrix}$	A	1023	BG (DISSOLVE) $\begin{matrix} \text{FG} \\ \text{EG} \end{matrix}$	A
1024	BG (DISSOLVE) $\begin{matrix} \text{DR} & \text{EG} \\ \text{FG} & \text{DR} \end{matrix}$	A	1025	BG (DISSOLVE) $\begin{matrix} \text{EG} & \text{DR} \\ \text{FG} & \text{DR} \end{matrix}$	A
1026	BG (DISSOLVE) $\begin{matrix} \text{FG} & \text{DR} \\ \text{EG} & \text{DR} \end{matrix}$	A	1027	BG (DISSOLVE) $\begin{matrix} \text{DR} & \text{FG} \\ \text{DR} & \text{EG} \end{matrix}$	A
Y & C modify					
1030	BG (DISSOLVE) FG NEGATIVE COLOR	A	1033	BG (DISSOLVE) FG B & W	A
1040	BG (DISSOLVE) FG Y&C MASK	A	1043	BG (DISSOLVE) FG Y MASK	A
1046	BG (DISSOLVE) FG C MASK	A	1050	BG (DISSOLVE) FG MODIFY	A
1055	$\begin{matrix} \text{BG} & \text{FG} \\ \text{MODIFY} \end{matrix}$	A	1056	$\begin{matrix} \text{BG} & \text{FG} \\ \text{MODIFY} \end{matrix}$	A
1057	$\begin{matrix} \text{FG} \\ \text{MODIFY} \end{matrix}$ BG	A	1058	$\begin{matrix} \text{FG} \\ \text{MODIFY} \end{matrix}$ BG	A
Cut					
1059	FG (CUT) BG	T			

Freeze, Strobe, Cinema					
1065	BG (DISSOLVE) FG STROBE	A	1066	$\begin{matrix} \text{FG} \\ \text{RAW STROBE} \\ \text{BG} \end{matrix}$	A
1067	$\begin{matrix} \text{FG} \\ \text{COLOR STROBE} \\ \text{BG} \end{matrix}$	A			
Cropping					
1075	$\begin{matrix} \text{BG} & \text{FG} \\ \text{CROPPING} \\ \text{(fade)} \end{matrix}$	A			
Picture-in-picture					
1100	P in P	A	1101	P in P (auto centering)	A
1102	3D P in P (fade)	A	1103	3D P in P	A
1104	SKEW P in P (fade)	A	1105	SKEW P in P	A
1106	3D CIRCLE P in P (fade)	A	1107	3D CIRCLE P in P	A
1108	3D HEART P in P (fade)	A	1109	3D HEART P in P	A
Zoom up					
1130	FG ZOOM UP	A	1131	FG ZOOM UP (auto centering)	A

Appendixes

Effect Pattern Image List

Spotlight					
1150		A	1151		A
Dynamic mirror					
1200		T	1201		T
1202		T	1203		T
1204		T	1205		T
1206		T	1207		T
Stream					
1210		T	1211		T
1212		T	1213		T
Accordion					
1230		T	1231		T
1232		T	1233		T

Multi-screen					
1240		A	1241		A
Wave modulation					
1250		A	1251		A
1252		A	1253		A
1254		A	1255		T
1261		T	1262		T
1263		T	1264		T
1265		T	1266		T
1269		T	1270		T
1271		T			
Real paint					
1280		A	1281		A
1282		A	1283		A
Stained glass					
1285		A	1286		A
Slide					
1300		T	1301		T
1302		T	1303		T
1304		T	1305		T
1306		T	1307		T

Effect Pattern Image List

Appendixes

Split slide			
1330		1331	
1332			
1340		1341	
1343		1344	
1347		1349	
1350		1351	
1360		1361	
1362		1363	

(continued)

Split slide (continued)			
1370		1371	
1372		1373	
1380		1381	
1382		1383	
1385		1386	
1387		1388	
1390		1391	
1392		1393	
1394			

Appendixes

Effect Pattern Image List

Appendixes

Compress											
1500				T	1501				T		
1502				T	1503				T		
1504				T	1505				T		
1506				T	1507				T		
1508				T	1510				T		
1513				T	1514				T		
1522				T	1523				T		
Expand											
1530				T	1531				T		
1535				T							

2D rotation											
1600				T	1601				T		
1605				T	1606				T		
1612				T	1610				T		
2D rotation + Compress + Slide											
1620				T	1620				T		
1635				T	1635				T		
1643				T	1643				T		
2D rotation + Compress + Slide (modified)											
1690				T							

Appendixes

Effect Pattern Image List

Appendixes

3D rotation											
1700		1701		1702		1703		1704		1705	
1704		1705		1706		1707					
Door											
1730		1731		1732		1740					
1741		1742									
Split 3D rotation											
1750		1751		1752		1753					

3D rotation + Compress + Slide (modified)											
1760		1762									
1765											
1770		1780									
1781		1782									
1783		1800									
1802		1806									
1807		1810									
1811		1812									
1813		1814									
1815		1816									
1820		1821		1822		1823		1824			

Appendixes

Effect Pattern Image List

Appendix

Album turn		
1850		T
1852		T
1854		T
Flip, Tumble		
1900		T
1902		T
1906		T
1912		T
1920		T
1930		T
1940		T
1851		T
1853		T
1855		T
1901		T
1905		T
1909		T
1916		T
1921		T
1933		T
1941		T

(continued)

Flip, Tumble (continued)		
1942		T
1944		T
1946		T
1948		T
1950		T
1952		T
1955		T
1958		T
1960		T
1964		T
1943		T
1945		T
1947		T
1949		T
1951		T
1954		T
1956		T
1959		T
1962		T

Twist		
2000		T
2002		T
2001		T
2003		T

Appendix

Effect Pattern Image List

Appendixes

Page turn											
2100		2101		2102		2103		T			
2104		2105		2106		2107		T			
2108		2109		2110		2111		T			
2112		2113		2114		2115		T			
2120				2121				T			
2122				2123				T			
2124				2125				T			
2126				2127				T			
2128				2130		2131		T			
2132		2133		2134		2135		T			
2136		2137		2138		2139		T			
2140		2141		2142				T			
2143				2144				T			

A-44 Appendixes

Page turn (modified)											
2150		2151		2152		2153		2154		T	

Split page turn												
2160								2161				T
2162								2163				T
2164								2165				T
2166								2167				T

Sphere													
2200								2201					T
2202								2203					T
2204								2210					T
2211								2212					T
2213													T

Picture-in-picture (sphere)													
2250		A						2251		A			

Appendixes A-45

Appendixes

Effect Pattern Image List

Appendixes

Ripple			
2260		2261	
2262		2263	
2264		2265	
2266		2267	
2268		2269	

Burst, Explosion, Ring, Swirl			
2270		2271	
2272		2273	
2274		2275	
2276		2277	
2278		2279	

Amoeba, Melt, Lens			
2280		2281	
2282		2283	
2284			

Two-picture slide			
2300		2301	
2302		2303	
2304		2305	
2306		2307	

Two-picture slide, 2D rotation			
2320		2321	
2322		2323	
2324		2325	
2326		2327	
2328		2329	

Appendixes

Effect Pattern Image List

Appendixes

Two-picture rotation + Compress + Slide							
2340	BG					2341	BG
2342	BG					2343	BG
2344	BG					2345	
2346						2347	
2348						2349	
2350						2351	
2352						2353	
2354						2355	
2356						2357	

Two-picture intersect							
2360					2361		
2362					2363		
2364					2365		
2370					2371		
2372					2373		
2374					2375		

Appendixes

Effect Pattern Image List

Appendixes

Two-picture box					
2380		T	2381		T
2382		T	2383		T
2384		T	2385		T
2386		T	2387		T
2388		T	2389		T
2390		T	2391		T
2392		T	2393		T
2394		T	2395		T

Two-picture brick					
2400		T	2401		T
2402		T	2403		T
2404		T	2405		T
2406		T	2407		T
2410		T	2411		T
2412		T	2413		T
2414		T	2415		T
2416		T	2417		T
2418		T	2419		T

Appendixes

Effect Pattern Image List

Appendixes

Two-picture brick (flip type)			
2420		2421	
2422		2423	
2424		2425	
2426		2427	
2428		2429	
2430		2431	
2432		2433	
2434		2435	
2436		2437	
Split 3D rotation			
2470		2471	
2472		2473	

Masked flip			
2480		2481	
2482		2483	
2484		2485	
2486		2487	
2488		2489	
2490		2491	
2492		2493	
2494		2495	
2496		2497	
2498		2499	

Appendixes

Effect Pattern Image List

Appendixes

2ch picture-in-picture					
2500		A	2501		A
2502		A	2503		A
2504		A	2505		A
2506		A	2507		A
2508		A	2509		A
2510		A	2511		A
2512		A	2513		A
2514		A	2515		A
2516		A	2517		A
2518		A	2519		A

2ch picture-in-picture					
2520		A	2521		A
2522		A	2523		A
2524		A	2525		A
2526		A	2527		A
2530		A	2531		A
2532		A	2533		A
2534		A			
Two-picture page turn					
2550		T	2551		T
2552		T	2553		T
2554		T			

Appendixes

Effect Pattern Image List

Appendixes

Split page turn			
2560		2561	
2562		2563	
2564			
3D split			
2600		2604	
2605			
2610		2611	
2612		2613	
2620		2624	
2625			

3D split flip			
2630		2631	
2632		2633	
Multi-cube			
2640		2641	
2642		2643	
2644		2645	
2646			
2650		2651	
Three-picture multi-cube			
2660		2661	

Appendixes

Effect Pattern Image List

Appendixes











































Special wipe					
2690		T	2691		T
2692		T			T
3D page turn					
2700		T	2701		T
2702		T	2703		T
2704		T	2705		T
2710		T	2711		T
2712		T	2713		T
2714		T	2715		T
3D twist					
2720		T	2721		T
2722		T	2723		T
2724					







































3D box twist					
2730		T	2731		T
2732		T	2733		T
2734		T	2735		T
2736		T	2737		T
2738		T	2739		T
3D modeling effect					
2740		T	2750		
2751		T	2752		T

Appendixes

Effect Pattern Image List

Appendixes

3D beveled edge, Picture-in-picture			
2800	 	A	2801   A
2802	 	A	2803   A
2804	 	A	2805   A
3D modeled edge, Picture-in-picture			
2810		A	2811   A
2812	 	A	2813   A
3D cube, 3D brick			
2820		A	2821    A
2822		A	2823    A
2824		A	2825    A
2826		A	2827    A
2830		A	2831    A
2832		A	2833    A

3D cylinder, Sphere, Heart			
2840	 	A	2841   A
2842	 	A	2843   A
2844	 	A	2845   A
3D wave, 3D flag			
2850	 	A	2851   A
2852	 	A	2853   A
2854	 	A	2855   A
2856	   	A	2857     A
Kaleidoscope			
2860		A	2861  A
3D crystal, Mirror cube			
2865	   	A	2866  A

Appendixes

Effect Pattern Image List

3D object effect					
2870		A	2871		A
2872		A	2873		A
2874		A	2875		A
2876		A	2880		A
2881		A			

Appendixes

To Exchange the Button Labels

After changing a pattern assignment, you can exchange the label on the numeric buttons. Proceed as follows.

- 1** Write the new pattern on one of the supplied exchange labels.
- 2** Insert the supplied tool into the hole at the side of the button and remove the button.
- 3** Insert the tool into the slot on the side of button, lifting up the white button cap, and remove the cap.
- 4** Remove the old label and insert the new label.
- 5** Replace the white button cap.
- 6** Return the button to its original position.

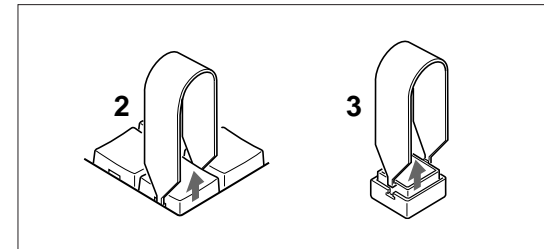

Appendixes

Specifications

General

Signaling system	DFS-700: NTSC DFS-700P: PAL
Power requirements	DFS-700: 100 V AC, 50/60 Hz DFS-700P: 220/240 V AC, 50/60 Hz
Operating voltage	DFS-700: 90 to 130 V AC, 47 to 63 Hz DFS-700P: 180 to 260 V AC, 47 to 63 Hz
Power consumption	200 W
Peak inrush current	(1) Power ON, current probe method: 24 A (240 V) (2) Hot switching inrush current, measured in accordance with European standard EN55103-1:13 A (230 V)
Operating temperature	0°C to 40°C (32°F to 104°F)
Dimensions	Control panel: 440 × 121 × 287 mm (w/h/d) (17 ³ / ₈ × 4 ⁷ / ₈ × 11 ³ / ₈ inches) Processor: 440 × 133 × 520 mm (w/h/d) (17 ³ / ₈ × 5 ¹ / ₄ × 20 ¹ / ₂ inches)
Mass	Control panel: Approx. 3 kg (6 lb 9 oz) Processor unit: Approx. 14 kg (30 lb 13 oz)

Signal processing

Sampling rate	Y: 13.5 MHz, R-Y/B-Y: 6.75 MHz, KEY: 13.5 MHz
Quantizing	Y/R-Y/B-Y: 8 bits, KEY: 8 bits
Linearity (composite output)	
Differential gain	Less than 3.5% (composite input) Less than 2% (component, S-Video input)
Differential phase	Less than 2.5° (composite input) Less than 1.0° (component, S-Video input)
Frequency response	0 to 5 MHz + 0.5 dB/-1 dB

S/N	More than 50 dB (composite) More than 55 dB (component, S-Video)
System delay	1 frame Preread mode: Background bus only 4H

Input signals

VIDEO INPUT COMPOSITE	BNC type (Y/R-Y/B-Y) × 4 (with BKDF-701: × 8) Y: 1.0 Vp-p, 75 ohms R-Y/B-Y: 0.756 Vp-p, 75 ohms
RGB	To use some of the above COMPONENT connectors. R/G/B: 0.756 Vp-p, 75 ohms, sync on green
COMPOSITE (with BKDF-702/702P)	BNC type × 4 VIDEO: 1.0 Vp-p, 75 ohms, sync negative
S-VIDEO (with BKDF-702/702P)	DIN × 4 Y: 1.0 Vp-p, 75 ohms, sync negative, C (BURST): 0.286 Vp-p, 75 ohms
REF. VIDEO	BNC type × 2, loop through SYNC: 0.286 Vp-p BURST: 0.286 Vp-p
SDI INPUT	BNC type × 4 (with BKDF-701: × 8) 270 Mb/s, compliant with SMPTE- 259M
DSK KEY IN	BNC type × 2, loop through 1.0 Vp-p, 75 ohms, sync negative

Output signals

PGM OUT	
SDI	BNC type × 2 270 Mb/s, compliant with SMPTE- 259M
COMPONENT	BNC type (Y/R-Y/B-Y) × 2 Y: 1.0 Vp-p, 75 ohms, sync negative R-Y/B-Y: 0.756 Vp-p, 75 ohms
COMPOSITE	BNC type × 2 Video: 1.0 Vp-p, 75 ohms, sync negative
S-VIDEO	DIN × 2 Y: 1.0 Vp-p, 75 ohms, sync negative C (BURST): 0.286 Vp-p, 75 ohms
CLEAN OUT	BNC type × 1 SDI: 270 Mb/s, compliant with SMPTE-259M
BLACK BURST OUT	BNC type × 3 SYNC: 0.286 Vp-p BURST: 0.286 Vp-p

Control signals

EDITOR	D-sub, 9-pin × 1 (RS-422A)
GPI T 1/2	BNC type × 2, TTL level, active low
PANEL	D-sub, 25-pin × 1
TALLYL	D-sub, 25-pin × 1, relay contact output × 8
TERMINAL	USB × 1

Recommended equipment and cables

Editing control unit	PVE-500, BVE-900/910/2000, BVE-600
VTR	DSR-2000/2000P, DNW-75/75P
Audio mixer	SRP-V200R
Cables	RCC-5G/10G/30G 9-pin remote control cables

Supplied accessories

AC power cord (1)
25-pin control cable, 10 m (1)
Button labels (1 set)
Tool for removing key tops (1)
Operation manual (1)

Design and specifications subject to change without notice.

Glossary

A-roll edit

An edit using one player and one recorder for basic cut editing.

A/B roll edit

An edit using two players and one recorder, to permit special effects such as mix and wipe.

B–Y signal

A color difference signal. The blue signal minus the Y signal.

Background picture

In animation effects, the picture into which the foreground picture is inserted. In transition effects, the picture that is replaced as the effect progresses (FROM picture). The picture selected with the BACKGROUND bus buttons.

Background through mode

In the DFS-700/700P, an output mode in which the video input of the background bus and the video input of the foreground bus are mixed for output. Normally the two pictures are delayed by 1 frame, but in pre-read editing the background bus picture is delayed by 4 lines. Pre-read editing is enabled by inserting the input of the background bus into the output of the recorder VTR. In this state, the foreground bus input delay becomes 1 frame + 4 lines. Therefore, the VTR output that is inserted into the foreground bus must be read ahead by 1 frame.

Black burst

A sync signal composed of composite sync and burst signals.

Bus

An internal signal path. Signals selected for input to the bus are passed on to the next process.

Chroma

In colors, hue and saturation.

Chroma key

Key effect in which a particular color (usually a highly saturated blue) is used to cut holes in a background picture.

Color bar

A test signal displayed on a monitor screen as vertical stripes of different colors, used to adjust hue and saturation.

Color matte

An internally generated color signal with adjustable hue, saturation, and luminance.

Component signal

Video signal containing separate luminance (Y) and color difference (R–Y, B–Y) video components.

Composite signal

Video signal containing video, color burst, and sync signals.

Cross-point

An electronic switch where video signal lines cross. When the switch is closed, usually by pressing a button, multiple input signals and one or more output signals are allowed to pass.

Cut

An instantaneous switch from one picture to another, or the instantaneous insertion or deletion of a key signal.

Downstream key (DSK)

Effect used to superimpose characters or graphics over output signals. Called downstream key because superimposing takes place in the final stages of processing after other effects have been applied. Requires a key source signal to define the outlines of the characters or graphics, and a key fill signal to fill the outlines. *See also "title key".*

Editing control unit

A video editor with functions for remote control of VTRs, video switchers, audio switchers, and other video editing equipment.

Field

In the NTSC color television system, 262.5 horizontal scanning lines. Odd lines are scanned for the first field before returning to the top of the screen to scan even lines. A frame is composed of two fields: the odd and even fields.

Foreground picture

In animation effects, the picture inserted into the background picture. In transition effects, the picture left on the screen after the effect finishes (TO picture). The picture selected with the FOREGROUND bus buttons.

Frame

Two fields, containing all the information in a complete picture.

Frame synchronizer

A device used to bring the timing of unsynchronized video into conformance with a local reference signal.

Gen-lock

To synchronize output signals to an external sync signal.

GPI

Abbreviation of general purpose interface. An interface used to carry out remote control from editing control units lacking a formal interface.

Hue

The attribute of colors that allows them to be classified as red, green, blue, and so on. Red and pink have the same hue, but different saturations.

Key clip

In luminance keys, to specify a reference luminance level. The part of the signal above the reference level is used as the key source signal. *See also "key source".*

Key fill

A signal used to fill the hole cut with the key source signal.

Key frame

User program effect data which defines the effect at a specific point. User program effects are made up of sequentially executed key frames.

Key gain

The sensitivity of circuits, which can be adjusted with the switcher's key gain control. This is done to obtain the desired blurring of key edges.

Key invert

In luminance key, to reverse the polarity of a key source signal so that the hole is cut with the darker part of the signal.

Key mask

To hide part of a title key or downstream key signal so that only the desired part is used.

Key source

A signal used to cut a hole in a background picture for insertion of a key fill signal.

Luminance key

Key effect in which a luminance signal is used to define the outlines of characters or graphics.

Luminance signal

The part of a video signal that carries brightness information. Also called the Y signal.

Mix

Effect in which one signal fades in while another fades out. Also called dissolve.

Pre-read editing

A/B roll editing using the output (playback) of the recorder VTR and a player VTR.

Preroll

Running a videotape a certain distance before the edit IN point in order to bring the tape to a steady speed and synchronize it with other tapes.

Postroll

Running a videotape a certain distance past the edit OUT point in order to monitor the video that follows.

R–Y signal

A color difference signal. The red signal minus the Y signal.

RGB signal

A signal format in which red, green, and blue signals are transmitted separately. A separate sync signal may be sent, or the sync signal can be added to the green signal. The DFS-700/700P uses the latter method.

Saturation

The extent to which a color has been diluted by white. Pure red is fully saturated, while pink is diluted.

SDI

A serial component digital signal.

S-video signal

A video signal with separate luminance (Y) and chrominance (C) components. As opposed to composite video, S-video provides higher quality by eliminating interference between the Y and C signals.

Snapshot

Data containing the settings of specific controls on the control panel. Snapshots can be saved and recalled to restore the control panel to a desired state.

Subcarrier (SC)

The part of a video signal that carries color information. The amplitude represents saturation, and the relative phase against the color burst signal represents hue. Also called the color subcarrier.

Title key

Effect used to superimpose foreground characters or graphics on a background. Requires a key source signal to define the outlines of the characters or graphics, and a key fill signal to fill the outlines. *See also "downstream key".*

Transition

A period during which one picture is replaced by another, or a period during which a key is inserted or deleted.

Wipe

A transition effect in which one picture moves in to replace another. Often the new picture appears as a geometrical shape such as a circle or star.

YUV signal

An analog component signal, consisting of a luminance (Y) signal, a color difference signal U (B–Y) and a color difference signal V (R–Y).

Index

A

A/B roll editing
 BVE-600 5-6
 BVE-900/2000 series 5-8
 GPI signals 5-12
 PVE-500 5-3
 connections 6-5
 AC IN connector 2-15
 Advanced operations 4-1
 Angle 3-42
 Animation type effects 3-17, A-21
 AUTO TRANS button 2-4, 3-54
 AUXILIARY buttons 2-2, 3-16

B

BACKGROUND bus button 2-3, 3-13
 Background image 3-12
 Basic operation 3-1
 BEVELD EDGE button 2-8, 3-27
 BKDF-701/702/702P/711/712 1-3
 BLACK BURST OUT 1, 2, 3 connectors 2-15
 BLACK button 2-2, 2-3
 BORDER button
 DSK section 2-8, 3-48
 EDGE section 2-8, 3-26
 Boundary, modification 3-26
 Button labels A-63
 BVE-600 5-5
 BVE-900/910/2000 5-8

C

CCR button
 delegation section 2-2, 3-59
 menu control section 2-9, 3-59
 Changing direct pattern assignments 4-1
 Characters and graphics, inserting
 downstream key 3-45
 title key 3-33
 Chroma keying 3-36
 auto 3-37
 manual 3-40
 CLEAN OUT connector 2-14
 Color background 3-14
 Color cancel function 3-42
 Color correction 3-59
 Color matte adjustment 3-57

Connections 6-1
 A/B roll editing system 6-5
 basic system 6-2
 key signal 6-2
 preread editing 6-4
 Control from editing control units 5-1
 Control knobs 2-10
 Control panel 2-1
 delegation section 2-1, 2-2
 EDITOR button 2-1, 2-7
 effect control section 2-2, 2-10
 effect transition section 2-2, 2-4
 fade-to-black and DSK section 2-1, 2-6
 GPI button 2-1, 2-7
 location section 2-1, 2-12
 pattern/numeric keypad 2-1, 2-5
 primary cross-point bus section 2-1, 2-3
 snapshot section 2-1, 2-11
 menu control section 2-2, 2-7
 25-pin connector 2-1, 2-12
 user program section 2-2, 2-11
 CRK button 2-7, 3-38
 CROP 3-27
 CUT button 2-4

D

DEL button 2-6
 Delegation buttons 2-2, 3-16
 Delegation section 2-1, 2-2
 Demonstration
 factory setting 3-8
 snapshot 4-23
 Density function 3-43
 DIRECT PATTERN button 2-5, 3-23
 DIRECT RECALL button 2-5, 4-23
 Direct pattern selection 3-23
 changing assignments 4-1
 selectable effects 3-17
 Display window mode indicators 2-4
 DME switcher introduction 3-1
 DOWN button 2-6
 Downstream key 3-45
 border 3-48
 masking 3-50
 on and off using GPI signals 5-13
 Downstream keyer section 2-8
 Drop border 3-49
 DSK button 2-7, 3-47
 DSK FILL button 2-2, 3-47
 DSK indicator 2-4, 3-51
 DSK KEY IN connectors 2-15

DSK PVW button 2-6
 DSK section 2-6, 2-8

E

EDGE section 2-8
 EDIT button 2-11, 4-11
 EDIT display 2-11, 4-11
 Editing user program effects 4-12
 Editing control unit
 BVE-600 5-5
 BVE-900/2000 series 5-8
 control using GPI signals 5-11
 preread editing 5-14
 PVE-500 5-1
 EDITOR connector 2-14
 EDITOR button 2-1, 2-7
 EFFECT button 2-4
 EFFECT indicator 2-4, 3-51
 Effects
 control section 2-1, 2-10
 control parameter list A-5
 example 3-18
 executing 3-54
 motion types A-21
 pattern image list A-29
 pattern variant forms and decorations A-22
 transition section 2-1, 2-4
 type list A-3
 types 3-17
 selection, using pattern buttons 3-23
 selection, using pattern numbers 3-24
 ENTER button 2-6
 External key mode 3-46
 Example effects 3-18
 Example operation (1) 3-2
 Example operation (2) 3-5

F

Fader lever 2-5, 3-54
 Fader lever stiffness adjusting screw 2-5
 Fade to black 3-63
 Fade-to-black and DSK section 2-1, 2-6
 FADE TO BLACK button 2-6
 Features 1-1
 FOREGROUND bus button 2-3, 3-13
 Foreground image 3-12
 FRAME button 2-2, 3-60
 Frame memory buttons 2-2, 3-61
 FREEZ button 2-2, 3-61
 FRGD 2 button 2-2, 3-16

Index

Front panel 2-13
 FTB indicator 2-4, 3-51
 F1 to F5 buttons 2-10

G

Glossary A-66
 GPI signals 5-11
 GPI button 2-1, 2-7
 GPI/T 1 and 2 connectors 2-15

H

HOLD INPUT button 2-12, 4-22

I

Images
 auxiliary bus 3-16
 background 3-12
 foreground 3-12
 INITIAL button 2-10
 Initializing
 assignment of direct pattern 4-2
 menu settings 2-10
 snapshot 4-24
 user program 4-19
 user settings 6-10
 INT VIDEO button 2-2, 2-3
 Inverting polarity
 downstream key 3-48
 title key 3-35

J

Joystick 2-12

K

Key fill signal
 downstream key 3-47
 title key 3-35
 Key frame 4-3
 adding 4-14
 assigning to a numeric button 4-16
 copying 4-17
 deleting 4-15
 Keypad 2-1, 2-5
 Key signal connections 6-3
 Key source signal 3-45

L

LAST X/INS 2-6
 LEARN button 2-11, 4-21
 LIGHTING button 2-9
 Linear effects 4-4
 Location and function of parts
 and controls 2-1
 LOCATION button 2-12, 3-29
 Location section 2-1, 2-12
 LUM button
 DSK section 2-8, 3-46
 TITLE section 2-7, 3-35
 Luminance key 3-33

M

MASK button
 DSK section 2-8, 3-50
 TITLE section 2-8, 3-45
 Masking
 downstream key 3-50
 title key 3-44
 MATTES button 2-9, 3-57
 MEMORY button 2-2, 2-3, 3-16
 Menu control section 2-1, 2-7
 Menu display 2-10
 Menus 3-10
 MIX button 2-4
 Modifying
 edge 3-26
 pattern 3-28

N

Nonlinear effects 4-4
 N/R button 2-5, 3-52

O

Option board 1-3
 Overview 1-1

P, Q

P IN P/RST button 2-6
 PAGE button 2-10
 PANEL connector 2-14
 Pattern
 changing position and size 3-28
 entering pattern number 3-23
 image list A-29
 modifying 3-31

PATTERN ADJ button 2-10
 PATTERN/KEY PAD buttons 2-6, 4-1
 PATTERN NUMBER display window
 2-5, 3-24
 Pattern number specification mode 3-23
 Pattern/numeric keypad 2-1, 2-5
 PGM OUT connectors 2-14
 Picture-in-picture 3-5
 Power switch and indicator 2-13
 Preread editing 5-14
 connections 6-4
 Primary cross-point bus section 2-1, 2-3
 Primary inputs and signal formats 6-9
 Processor unit 2-13
 PVE-500 5-1
 PVW connector 2-15

R

Rear panel 2-13
 RECALL button 2-11, 4-22
 REF. VIDEO IN connectors 2-15
 REV button 2-5, 3-52

S

Saturation 3-57
 Self-keying mode 3-46
 Sequence of operations 3-1
 SET button
 effect transition section 2-4, 3-51
 pattern/numeric keypad 1 2-5, 3-24
 SET UP button 2-9, 6-7
 Setup menu
 system setup 6-7
 system information display 6-8
 input video 6-8
 organization 6-7
 output video 6-9
 control panel 6-10
 initializing user settings 6-10
 loading user settings 6-10
 saving user settings 6-10
 SHIFT button 2-9
 SNAP SHOT number display 2-11, 4-21
 Snapshots 4-20
 demonstration 4-23
 reinitializing 4-24
 recalling 4-22
 saving 4-21
 section 2-1, 2-11
 SOFT button 2-8, 3-27
 Soft edge 3-26

Specifications A-64
 STATUS display 2-11, 4-10
 SUPER BG button 2-2, 3-16

T

TALLY connector 2-14
 TERMINAL connector 2-14
 3D mapping effect option 1-3
 TITLE button 2-4, 3-34
 Title key 3-33
 chroma key 3-36
 luminance key 3-33
 masking 3-44
 TITLE section 2-7, 3-35
 TITLE 1 SOURCE/TITLE 2 SOURCE
 button 2-2, 3-16
 TRAIL SHADOW button 2-8
 TRANS RATE display window 2-4, 3-51
 Transition
 direction 3-52, 3-56
 indicator 2-5, 3-56
 time 3-51
 Transition type effects 3-17, A-21
 25-pin connector 2-1, 2-12
 Types of effect 3-17

U

UP button 2-6
 User settings 6-10
 User modifiable effects 3-31
 User program effects
 constructing 4-3
 creating 4-10
 deleting 4-19
 editing 4-12
 executing 4-18
 modification parameters 4-5
 type 4-4
 User program section 2-1, 2-11

V

VIDEO INPUT connectors 2-14

W, X, Y

Warning messages A-1
 Wipe 3-2

Z

Z knob 2-12, 3-30



Index



Index

